



SENSING AND CONTROL

## Sensors and Switches for Potential Medical Applications

# Potential Applications Overview

Potential Application	Honeywell Product	Product Function in Application	Customer Benefits
<b>RESPIRATORY</b>			
<b>Anesthesia Delivery Machines</b>	Airflow Sensor	measures the flow of air, oxygen, and nitrous oxide so that the specified mixture, as set by the doctor, is delivered to the patient	accurate, customizable, stable, low pressure drop, saves time and money
	Magnetic Position Sensor IC	provides enhanced output accuracy for smooth motor control that reduces noise and vibration in motor assembly fan systems	quiet, cost-effective, efficient, effective, accurate
	Pressure Sensor – Board Mount	measures air and oxygen pressure so that the pressure doesn't exceed a desired level	stable, easy to use, accurate, improves patient safety, easy to design in, compatible
	Pressure Sensor/Transducer – Heavy Duty		
	Thermistor	monitors and controls the air temperature	flexible, cost-effective, small size
<b>Oxygen Concentrators</b>	Airflow Sensor	detects ultra-low levels at 0.1 cm <sup>3</sup> to detect when the patient exhales and when the system should reduce airflow	improves patient comfort, eases patient breathing, quiet, portable, reliable
	Hour Meter	tracks machine usage in hours and tenths of an hour via a readily-visible readout	accurate, reliable, readable, rugged
	Pressure Sensor – Board Mount	detects when the patient begins to inhale so that oxygen can then be delivered efficiently and effectively	stable, sensitive, accurate, reliable, cost-effective, efficient
	Pressure Sensor/Transducer – Heavy Duty	senses pressure from the surge tank, providing feedback to the compressor which allows the compressor to maintain the desired pressure level	sensitive, accurate, reliable, cost-effective, efficient
	Pressure Switch	acts as a high pressure warning, alerting the user by activating an indicator light where the pressure exceeds a specified limit	accurate, reliable, extended life, one-stop shopping
<b>Sleep Apnea Machines</b>	Airflow Sensor	monitors the patient's breathing and sends an output that reduces the flow of the machine's internal blower fan when the patient starts to exhale	improves patient comfort, eases patient breathing, quiet, portable, reliable
	Flexible Heater Assembly	vaporizes water so that a comfortable breathing environment can be provided	flexible, customizable, improves patient comfort and safety, stable, easy to implement
	Magnetic Position Sensor IC	provides enhanced output accuracy for smooth motor control that reduces noise and vibration in motor assembly fan systems	quiet, cost-effective, improves patient safety, efficient, effective, accurate
	Humidity Sensor	monitors the amount of humidified air to provide adequate air moisture to the patient	accurate, flexible, cost-effective, durable
	Pressure Sensor – Board Mount	monitors the pressure of air that is delivered to the patient	stable, reliable, efficient, accurate, sensitive
	Thermistor and Pre-Packaged Temperature Probe	provides warm, moist air	accurate, effective design, flexible
	Thermostat	onboard devices on flexible heaters for temperature control	customizable, flexible, small
<b>Ventilators</b>	Airflow Sensor	measures the flow of air and oxygen so that the specified mixture, as set by the doctor, is delivered to the patient	accurate, customizable, stable, low pressure drop, saves time and money
	Flexible Heater Assembly	heats water to a vapor and introduces it into the air stream	flexible, customizable, improves patient comfort and safety, stable, easy to implement
	Magnetic Position Sensor IC	provides enhanced output accuracy for smooth motor control that reduces noise and vibration in motor assembly fan systems	quiet, cost-effective, improves patient safety, efficient, effective, accurate
	Humidity Sensor	helps deliver warm and moist air by being coupled to a microcontroller designed to measure the humidity of the air stream and signal the controller that the desired level of moisture is present	accurate, flexible, cost-effective, durable
	Pre-Packaged Temperature Probe	monitors air temperature	flexible, customizable
	Pressure Sensor – Board Mount	measures air and oxygen pressure so that the pressure doesn't exceed a desired level	stable, easy to use, accurate, improves patient safety, easy to design in
	Pressure Sensor/Transducer – Heavy Duty	provides a sensing solution when high pressure, steel pressure port interface and/or corrosive media are used	easy to use, accurate, improves patient safety, easy to design in
	Thermistor	monitors and controls the air temperature	flexible, cost-effective, small
<b>KIDNEY DIALYSIS MACHINES</b>			
<b>Kidney Dialysis Machines</b>	Flexible Heater Assembly	provides controlled heat for blood or dialysate warming to body temperature prior to re-entry into the body	flexible, customizable, enhances patient comfort, improves patient safety, stable, simplifies system qualification
	Force Sensor	a) detects the presence or absence of a fresh dialysate cartridge before the machine can be used; b) monitors the flexible tubing pressure of the dialysate to detect that the pressure doesn't exceed a specified level; c) monitors the weight of the dialysate to detect whether there is a specified amount of dialysate in the fresh dialysate cartridge	reliable, sensitive, stable
	Magnetic Position Sensor IC	provides reliable, accurate output for smooth motor control that reduces noise and vibration in the machine's motor assembly and improves its efficiency	quiet, cost-effective, energy-efficient, accurate
	Infrared Sensor	used with an encoder wheel on the pump shaft to count shaft rotation	reliable, works in contaminated environments, enables maximum position resolution

Potential Application	Honeywell Product	Product Function in Application	Customer Benefits
<b>Kidney Dialysis Machines (Continued)</b>	Pressure Sensor – Board Mount	obtains a direct, in-line continuous dialysate and venous pressure measurement in the dialysis membrane without interrupting flow	stable, efficient, accurate, easy to design in, small, extended life
	Pressure Sensor/Transducer – Heavy Duty	when located in a Cartridge, may be used to monitor pressure in the flexible tubing that carries blood or dialysate to provide continuous feedback of line pressures and pump control	
	Thermistor	provides temperature measurement for enhanced control of the permeation rate across the dialysis membrane	flexible, cost-effective, small
<b>INFUSION, INSULIN, AND SYRINGE PUMPS</b>			
<b>Infusion, Insulin, and Syringe Pumps</b>	Flexible Heater Assembly	conforms to the infusion pump's surface that requires heating, allowing for the capability of maintaining specific temperatures at predetermined levels	flexible, customizable, improves patient safety, stable, simplifies system qualification
	Force Sensor	provides an occlusion detector to detect blockage in the infusion or insulin pump's tube that delivers the medication to the patient	sensitive, stable, reliable, easy to use, portable
	Magnetic Position Sensor IC	provides reliable, accurate output for smooth motor control that reduces noise and vibration in the pump's motor assembly and improves its efficiency	quiet, cost-effective, energy-efficient, accurate
	Infrared Sensor	used with an encoder wheel on the pump shaft to count shaft rotation	reliable, durable, max resolution
	Pressure Sensor – Board Mount	monitors and controls the flow of fluid	accurate, easy to design in, stable
<b>DIAGNOSTICS/ANALYTICAL EQUIPMENT</b>			
<b>Gas Chromatography</b>	Airflow Sensor	regulates the flow rate to eliminate outgasing	reliable, reduces risk of contamination, accurate, stable, easy to implement
	Pressure Sensor – Board Mount	senses/controls pressure of gas stream to maintain a precise flow	accurate, stable
<b>Blood Analyzers</b>	Infrared Sensor	used with an encoder wheel on the pump shaft to count shaft rotation	reliable, works in contaminated environments, enables maximum position resolution
	Pressure Sensor – Board Mount	regulates pressure in the pump system to draw and transport the samples	accurate, reliable, stable, repeatable, contaminant and corrosion resistant, product availability
	Thermistor	monitors temperature of chamber, lamps, and motors to prevent overheating	flexible, cost-effective, small
<b>PATIENT MONITORING SYSTEMS</b>			
<b>Respiratory Monitoring</b>	Airflow Sensor	monitors patient's respiratory function	accurate, customizable, stable, low pressure drop, saves time and money
<b>Blood Pressure Monitoring</b>	Pressure Sensor – Board Mount	measures blood pressure	stable, accurate
<b>Blood Glucose Monitoring</b>	Pressure Sensor – Board Mount	controls the pumps used to draw the blood and return it to the patient so that the pressure does not rupture the veins	improves patient safety with enhanced stability and low drift, portable, accurate
<b>Temperature Monitoring</b>	Thermistor	monitors patient temperature	flexible, cost-effective, small
<b>HOSPITAL HARDWARE</b>			
<b>Medication Dispensing Cabinets</b>	Magnetic Position Sensor IC	enables remote locking and unlocking of medication dispensing cabinet drawers	allows for enhanced security, minimizes medication dispensing errors, reliable, cost-effective, energy-efficient, size reduction, on-time delivery
<b>Infant and Laboratory Incubators</b>	Flexible Heater Assembly	can be applied to the incubator door to help heat internal temperature and maintain clear visibility through the door wall	total thermal management solution, uniform heating, eases system qualification, flexible
	Humidity Sensor	monitors the incubator system to maintain humidification level in the chamber with accurate dew-point and humidity measurement	stable, reliable, allows application flexibility, cost-effective, durable
	Thermistor	monitors temperature	flexible, cost effective, small
<b>Blood Pressure Monitors</b>	Pressure Sensor – Board Mount	measures blood pressure	portable, stable, accurate
<b>Hospital Beds</b>	MICRO SWITCH™ Position Switch	determines min/max position of electrically adjustable beds	accurate, repeatable, durable, effective design, small, light weight
	Pressure Sensor – Board Mount	measures air pressure and controls the inflation and deflation of the mattress air columns to prevent bedridden patients from developing bedsores	accurate, reliable, stable
<b>SURGICAL INSTRUMENTS</b>			
<b>Surgical Fluid Management Systems</b>	Force Sensor	can help regulate the pressure at the pump head of a fluid management system, and as a back-up safety device to the direct pressure measurement at the joint	rugged design, stable, reliable, portable, and energy-efficient
	Pressure Sensor – Board Mount	senses pressure directly at the joint site during arthroscopic surgery	accurate, improves patient safety
<b>DENTAL EQUIPMENT</b>			
<b>Dental Imaging and Dental Chairs</b>	Magnetic Position Sensor IC	provides accurate motion control and positioning of the dental imaging system	accurate, energy-efficient, fast response, reliable
<b>Dental Imaging Systems</b>	Infrared Sensor	obtains dental images	reliable, works in contaminated environments, enables maximum position resolution
<b>Pressure-Operated Dental Instruments</b>	Pressure Sensor – Board Mount	keeps the water flow constant and at an adjusted level, allowing smooth operation of the dental instrument	accurate, reliable, stable, water-resistant, contaminant-resistant



## Table of Contents

### Respiratory

#### Anesthesia Delivery Systems ..... 4

- Airflow Sensors
- Magnetic Position Sensor ICs
- Pressure Sensors/Transducers
- Thermistors

#### Oxygen Concentrators ..... 7

- Airflow Sensors
- Hour Meters
- Pressure Sensors/Transducers
- Pressure Switches

#### Sleep Apnea Machines ..... 10

- Airflow Sensors
- Flexible Heater Assemblies
- Magnetic Position Sensor ICs
- Humidity Sensors
- Pressure Sensors
- Thermostats
- Thermistors and Pre-Packaged Temperature Probes

#### Ventilators..... 15

- Airflow Sensors
- Flexible Heater Assemblies
- Magnetic Position Sensor ICs
- Humidity Sensors
- Pre-Packaged Temperature Probes
- Pressure Sensors/Transducers
- Thermistors

#### Kidney Dialysis Machines..... 19

- Flexible Heater Assemblies
- Force Sensors
- Magnetic Position Sensor ICs
- Infrared Sensors
- Pressure Sensors/Transducers
- Thermistors

### Infusion, Insulin, and Syringe Pumps ..... 23

- Flexible Heater Assemblies
- Force Sensors
- Magnetic Position Sensor ICs
- Infrared Sensors
- Pressure Sensors

### Diagnostic/Analytical Equipment ..... 26

- Infrared Sensors
- Magnetic Position Sensor ICs
- Pressure Sensors
- Thermistors
- Airflow Sensors
- Pressure Sensors

### Patient Monitoring Systems ..... 30

- Airflow Sensors
- Pressure Sensors
- Thermistors

### Hospital Hardware..... 32

- Magnetic Position Sensors ICs
- Flexible Heater Assemblies
- Humidity Sensors
- Thermistors
- MICRO SWITCH™ Position Switches
- Pressure Sensors

### Surgical Instruments ..... 35

- Force Sensors
- Pressure Sensors

### Dental Equipment ..... 36

- Magnetic Position Sensor ICs
- MICRO SWITCH™ Watertight Switches
- Infrared Sensors
- Pressure Sensors





## For innovation that's well apart, there's only Honeywell Sensing and Control.

With more than 50,000 products ranging from snap-action, limit, toggle, and pressure switches to position, speed, pressure, and airflow sensors, Honeywell Sensing and Control (S&C) has one of the broadest sensing and switching portfolios available.

Honeywell sensor, switch, and control components are tailored to exact specifications for stronger performance, longer productivity, and increased safety. Enhanced accuracy and durability are built into every part, improving output and endurance. For our customers, this can reduce expenditures and operational costs. Our global footprint and channels help to competitively price such components for your chosen application and provide immediate technical support.

Our expertise in medical, aerospace and defense, transportation, and industrial industries means we offer products and solutions for a wide range of applications. But, an impressive product line is only one part. We possess unique engineering expertise and value-added capabilities.

While Honeywell's switch and sensor solutions are suitable for a wide array of basic and complex applications, our custom engineered solutions offer enhanced precision, repeatability, and ruggedness. We offer domain knowledge and technology

resources, along with a close working relationship, to develop and deliver cost-effective, individually tailored solutions. Whether clean-slate development or simple modifications to an existing design are needed, our expertly engineered solutions help to meet the most stringent requirements with world-class product designs, technology integration, and customer-specific manufacturing.

With a 75-year legacy in the switch and sensor business, Honeywell S&C has earned a reputation for reliability and excellence. Our strong product designs, Six Sigma Plus manufacturing environment, and robust testing facilities help provide quality out-of-the-box, as well as enhanced, sustainable performance down the line.

Global service, sourcing, and manufacturing. Industry-leading engineers. Value-added assemblies and solutions. Construction to required specifications. A one-stop, full-service, globally competitive supplier... Honeywell Sensing and Control.



# Respiratory

Honeywell is a leading sensor provider for many potential respiratory applications due to delivering the lowest pressure drop in the industry while providing enhanced sensitivity, accuracy, reliability, and stability with minimal drift over time. Honeywell's sensors and switches can be used in a variety of potential respiratory applications, including anesthesia delivery systems, oxygen concentrators, sleep apnea machines, and ventilators.



## Respiratory: Anesthesia Delivery Systems

An anesthesia machine is designed to deliver drugs to patients to help eliminate pain and other unwanted sensations. The continuous flow anesthetic machine provides an accurate and constant supply of medical gases (such as air, oxygen, and nitrous oxide), mixed with an accurate concentration of anesthetic vapor (such as isoflurane), and delivers this mixture to the patient at a desired pressure and flow.

### Sensor Solutions for Anesthesia Delivery Systems

- Airflow Sensors
- Magnetic Position Sensors ICs
- Pressure Sensors/Transducers
- Thermistors

### Airflow Sensors in Anesthesia Delivery Systems

#### Honeywell Zephyr™ HAF Series

Honeywell Zephyr™ Airflow Sensors are designed to measure the flow of air, oxygen, and nitrous oxide. They may be used so that the desired mixture, as set by the doctor, is delivered to the patient.

#### Benefits to Customer

- **High 2.5% accuracy:** Allows for very precise airflow measurement, often ideal for demanding applications with high accuracy requirements.
- **Customizable:** Allows the sensor to be designed to meet specific end-user needs.
- **High sensitivity at very low flows:** Allows the customer's application to detect presence or absence of airflow.
- **High stability:** Reduces errors due to thermal effects and null shift to provide accurate readings over time, often eliminating need for system calibration after printed circuit board (PCB) mount and periodically over time.

- **Low pressure drop:** Low pressure drop typically improves patient comfort in medical applications, and reduces noise and system wear in components such as motors/pumps.
- **Saves customers time and money:** Linear output provides a more intuitive sensor signal than the raw output of basic airflow sensors, often eliminating the need for customers having to linearize the output which can help to reduce production and design costs and implementation time.



HAF Series

## Magnetic Position Sensor ICs in Anesthesia Delivery Systems

### SS400 Series

The Hall-effect magnetic position sensor IC is designed to provide enhanced output accuracy for smooth motor control that reduces noise and vibration in a variety of potential applications, including anesthesia machine motor assembly fan systems. Its small size often allows for design into many compact, automated, lower-cost assemblies. A thermally balanced integrated circuit that is accurate over a full temperature range is designed to provide proper fan functionality.

#### Benefits to Customer

- **Accurate:** Enhanced accuracy and linearity over-span of 0~5 V output enables an extended sensing range.
- **Circuit protection:** Reverse voltage/polarity protection provides circuit protection.
- **Cost-effective:** Small sensor size can allow for compact designs and automated, lower-cost assemblies.
- **Effective:** Thermally-balanced integrated circuit that is accurate over the full temperature range enhances proper fan function.

- **Energy-efficient:** Low power consumption enhances energy efficiency.
- **Quiet:** Industry-leading sensor output accuracy for smooth motor control enables low audible noise and reduces motor vibration.



SS400 Series

## Pressure Sensors/Transducers in Anesthesia Delivery Systems

### Board Mount Pressure Sensors: TruStability® (HSC Series, SSC Series), ASDX Series, CPC Series (CPCL10GFC), SDX Series (SDX010IND4); Heavy Duty Pressure Sensors/Transducers: MLH Series, 19 mm Series, SPT Series

Honeywell's TruStability® and ASDX Series board mount pressure sensors are designed to measure air and oxygen pressure so that the pressure doesn't exceed a desired level. The CPC Series and the SDX Series may also be used with a customer-provided amplifier or an ASIC-based solution for a signal conditioned output. The MLH Series, 19 mm Series and SPT Series heavy duty pressure sensors/transducers are designed to provide a sensing solution when high pressure, steel pressure port interface and/or corrosive media are used. A male threaded pressure port and stainless steel wetted surfaces provide an air and oxygen inlet.

- TruStability® sensors' exceptional accuracy is a result of leading-edge technology, precise manufacturing processes, and temperature compensation and calibration. TruStability® sensors have two levels of accuracy: the standard accuracy SSC Series offers  $\pm 2\%$  total error band, and the HSC Series offers  $\pm 1\%$  total error band, better than most competitive products.
- ASDX Series offers accuracy of  $\pm 2\%$ .
- MLH Series' accuracy depends upon the pressure range: above 300 psi 0.25% FSS; below 300 psi 0.5% FSS; 19 mm Series offers 0.25% FSS; SPT Series offers 0.25% FSS.
- **Compatible:** Wetted materials or media isolated packaging (materials resistant to certain contaminants or media) offer compatibility with many harsh environments and resistance to certain contaminants.

- **Easy to design in:** Customization of desired pressure ranges, connections, calibration, and temperature compensation minimizes design-in effort.
- **Easy to use:** Small package with integrated signal conditioning reduces the number of components needed to implement the sensor, enabling size reduction of the end product.
- **Safe:** Enhanced accuracy, sensitivity, and stability with minimal drift over time and temperature enhances patient safety and therapy effectiveness by sensing when patients are breathing on their own to wean off the device.
- **Stable:** Stability is a measure of how little the output signal of the pressure sensor will change from measurement to measurement. The long-term stability of Honeywell's TruStability® sensors is the best in the industry.

#### Benefits to Customer

- **Accurate:** Enhances patient safety by measuring volume and mixture of gases to deliver the mixture at a desired pressure and flow.



TruStability® HSC Series, SSC Series



ASDX Series



CPC Series



SDX Series



MLH Series



19 mm Series



SPT Series

## Thermistors in Anesthesia Delivery Systems

### 192 Series, 194 Series

Air from anesthesia machines that is warm and moist helps to provide the patient with a comfortable breathing situation and may reduce sore throats caused by breathing cold, dry air. As such, the temperature of the air delivery system is often monitored and controlled to provide an air stream at a desired level of warmth. Discrete thermistor temperature sensors are installed directly into the air stream and are designed to monitor the air temperature. The sensor is coupled to a microcontroller designed to measure air stream temperature and interact with the controller that regulates the temperature of the air stream. Honeywell offers several types of configurations. The packaged sensors are available as discrete components for customer-built assemblies, or Honeywell can provide a full assembly solution that the customer may simply pigtail into the system.

### Benefits to Customer

- **Cost-effective:** Resistance temperature curve interchangeability designed to offer standardization of circuit components and simplification of design/replacement enhances cost-effectiveness.
- **Flexible:** Bare leads (192 Series) or insulated leads (194 Series) are designed to provide application flexibility.
- **Small:** Small size often eases use in confined spaces.

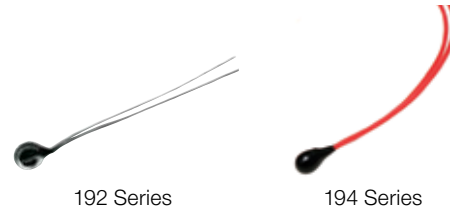

## Anesthesia Delivery Machine Block Diagram

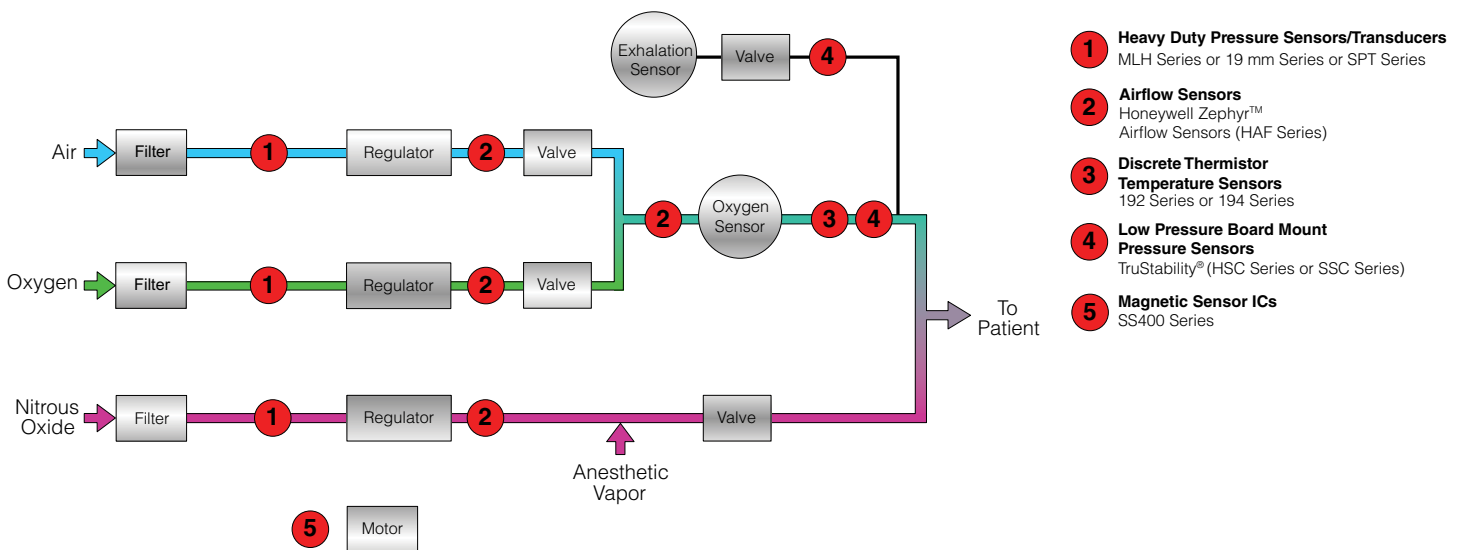



# Respiratory: Oxygen Concentrators

An oxygen concentrator reduces the amount of nitrogen in the air, increasing the oxygen level delivered to the patient. Oxygen concentrators are used with patients, such as those with lung disease, who have difficulty absorbing oxygen into the blood stream.

## Sensor and Switch Solutions for Oxygen Concentrators

- Airflow Sensors
- Hour Meters
- Pressure Sensors/Transducers
- Pressure Switches



### Airflow Sensors in Oxygen Concentrators

#### AWM90000 Series (AWM92100V)

Honeywell's airflow sensor for oxygen concentrators is designed to detect ultra-low flow levels at 0.1 cubic centimeters. This enhanced sensitivity may be used to detect when the patient exhales and when the system should reduce airflow, easing exhalation and improving patient comfort. Honeywell's airflow sensors deliver a low pressure drop (down to 0.2 cm H<sub>2</sub>O at 200 SLPM), leading to lower flow resistance and improved patient comfort.

#### Benefits to Customer

- Eases patient's breathing:** Delivers the lowest pressure drop in the industry (to 0.2 cm H<sub>2</sub>O at 200 SLPM), providing lower flow resistance, which eases breathing.
- Improves patient's comfort:** Enhanced sensitivity (the ability to detect ultra-low flow levels at 0.1 cubic centimeters) allows the sensor to detect when the patient exhales, sending a signal to reduce airflow, which eases the patient's exhalation and improves patient comfort.

- Portable:** Small sensor package size allows system size reduction, increasing portability, which can improve a patient's quality of life.
- Quiet:** Lower blower motor resistance allows for a quieter operation, improving the patient's ability to sleep.
- Reliable:** Enhanced quality and reliability (<100 ppm) can reduce downtime in many demanding operations.



AWM90000 Series

### Hour Meters in Oxygen Concentrators

#### 20000 Series

Honeywell's AC hour meter can track machine usage in hours and tenths of an hour via a readily-visible readout. This information may then be used to validate total hours of machine operation for maintenance purposes or usage on a per-patient basis to determine compliance or enhance billing accuracy. Hour meters are frequently found on the external control panel and are usually activated by the motor or compressor.

#### Benefits to Customer

- Accurate:** Accuracy of ± 0.02%.
- Readable:** Meter is readable with the power off.
- Reliable:** High tolerance to vibration and shock.
- Rugged:** Displayed hours cannot be altered—tamper-proof.



20000 Series

## Pressure Sensors/Transducers in Oxygen Concentrators

**Ultra-Low Pressure Board Mount Sensors:** CPCL Series (CPCL04GFC, CPCL10GFC), DUXL Series (DUXL01D);

**Low Pressure Board Mount Sensors:** TruStability® (HSC Series, SSC Series), CPC Series, SDX Series (SDX005IND4);

**Heavy Duty Pressure Transducers:** MLH Series

The low and ultra-low board mount pressure sensors may be used to detect when the patient begins to inhale so that oxygen can then be delivered efficiently and effectively. Not only can this enhance system response time, it can also minimize wasting oxygen when the patient isn't inhaling, allowing the oxygen concentrator to be smaller and to operate more efficiently. Smaller equipment size also means lower power consumption, as well as greater portability. The MLH Series heavy duty pressure transducers sense pressure from the surge tank, providing feedback to the compressor which allows the compressor to maintain the desired pressure level.

### Benefits to Customer

- **Accurate and sensitive:** Provides an enhanced level of sensitivity and accuracy over the entire range. TruStability® sensors' exceptional accuracy is a result of leading-edge technology, precise manufacturing processes, and temperature

compensation and calibration. TruStability® sensors have two levels of accuracy: the standard accuracy SSC Series offers  $\pm 2\%$  total error band, and the HSC Series offers  $\pm 1\%$  total error band, better than most competitive products.

- **Cost-effective:** Board mount pressure sensors optimize oxygen delivery, maximizing the amount of oxygen in the tank.
- **Efficient:** Heavy duty pressure transducers allow the user to monitor pressure within the specified range and adjust as needed, enhancing oxygen efficacy.
- **Reliable:** Provide enhanced quality and reliability.
- **Stable:** Stability is a measure of how little the output signal of the pressure sensor will change from measurement to measurement. The long-term stability of Honeywell's TruStability® sensors is the best in the industry.



TruStability® HSC Series,  
SSC Series



CPC/CPCL Series



DUXL Series



SDX Series



MLH Series

## Pressure Switches in Oxygen Concentrators

### 5000 Series

Honeywell's 5000 Series pressure switch is often located on the output of the oxygen concentrator's pressure regulator to alert the user by activating an indicator light if the pressure exceeds a specified limit. In some cases, it may also shut down the motor. Honeywell's pressure switch products have enhanced reliability and accuracy with fast transfer times (5 ms).

### Benefits to Customer

- **Accurate:** "Off the shelf" catalog pressure switch accurately monitors pressure level.
- **Extended life:** Rated at a 1 million cycle life allows for extended life of the product.
- **One-stop shopping:** Select from a family of applicable Honeywell products.
- **Reliable:** Reliable and repeatable set point minimizes costly repairs from over pressure.



5000 Series

## Oxygen Concentrator Block Diagram

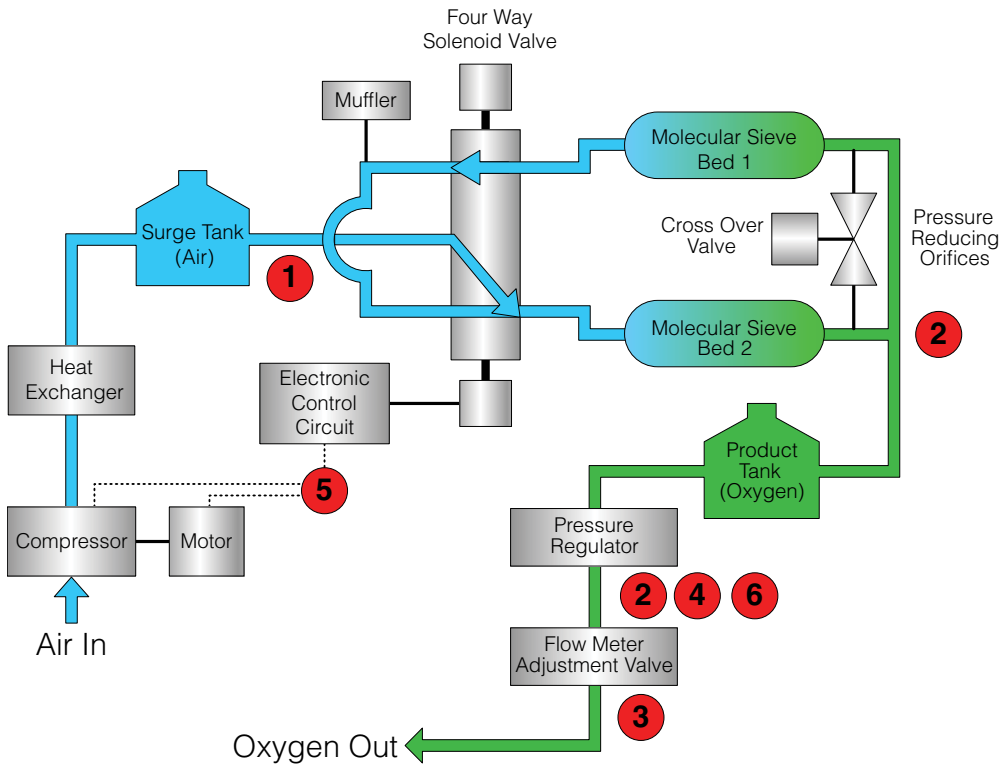

- 1 Heavy Duty Pressure Transducers**  
MLH Series
- 2 Low Pressure Board Mount Pressure Sensors**  
TruStability® (HSC Series, SSC Series), CPC Series, SDX Series (SDX005IND4)
- 3 Ultra-Low Pressure Board Mount Pressure Sensors**  
CPCL Series (CPCL04), DUXL Series (DUXL01D)
- 4 Airflow Sensors**  
AWM90000 Series (AWM92100V)
- 5 AC Hour Meters**  
20000 Series
- 6 Pressure Switches**  
5000 Series



# Respiratory: Sleep Apnea Machines

Sleep apnea is the repeated cessation of breathing during sleep, sometimes hundreds of times during the night and often for a minute or longer. If left untreated, sleep apnea may cause high blood pressure, cardiovascular disease, memory, and weight problems. The resulting lack of restful sleep may also be responsible for job impairment and motor vehicle accidents.

A main treatment option is the use of a Positive Airway Pressure (PAP) machine. The patient wears a mask that uses pressure to send air flowing through the nasal passages so they don't collapse and cause breathing to cease. There are three main categories of PAPs (in order of complexity/cost):

- **CPAP (Continuous Positive Airway Pressure)** provides a constant pressure to the patient. This positive pressure keeps the throat from collapsing during sleep and allows the patient to breathe freely without worry of episodes of non-breathing.
- **Auto-PAP (Automatic Positive Airway Pressure)** measures the resistance in a patient's breathing. The amount of continuous pressure delivered to the patient is then automatically tuned to the minimum required to maintain an unobstructed airway on a breath-by-breath basis.

- **Bilevel-PAP (Bilevel Positive Airway Pressure)** provides two levels of pressure: IPAP (Inspiratory Positive Airway Pressure) and a lower EPAP (Expiratory Positive Airway Pressure).

## Sensor Solutions for Sleep Apnea Machines

**Airflow Sensors**

**Flexible Heater Assemblies**

**Magnetic Position Sensors ICs**

**Humidity Sensors**

**Pressure Sensors**

**Thermostats**

**Thermistors and Pre-Packaged Temperature Probes**



## Airflow Sensors in Sleep Apnea Machines

**Honeywell Zephyr™ HAF Series; AWM90000 Series (AWM92100V)**

Honeywell's airflow sensors monitor the patient's breathing and send an output that informs the machine to reduce its internal blower fan when the patient starts to exhale. The resulting lowered resistance prevents the patient from feeling as though he is "fighting" against the machine when breathing, reducing discomfort. Patients often find that machines that use an airflow sensor to detect the breathing cycle tend to be more comfortable, and are more likely to use such machines more regularly than equipment without this feature. Some insurance companies and doctors often prefer this equipment due to greater patient compliance. These sensors have been used in Auto-PAP and Bilevel-PAP machines.

### Benefits to Customer

- **Meets high accuracy specifications:** High 2.5% accuracy allows for very precise airflow measurement, often ideal for demanding applications with high accuracy requirements (Honeywell Zephyr™).
- **Eases patient's breathing:** Delivers the lowest pressure drop in the industry (to 0.2 cm H<sub>2</sub>O at 200 SLPM), providing lower flow resistance which eases breathing.

- **Improves patient's comfort:** Enhanced sensitivity (the ability to detect ultra-low flow levels at 0.1 cubic centimeters) allows the sensor to detect when the patient exhales, sending a signal to reduce airflow which eases the patient's exhalation and improves patient comfort.
- **Portable:** Small sensor package size allows system size reduction, increasing portability, which can improve a patient's quality of life.
- **Quiet:** Lower blower motor resistance allows for a quieter operation, improving the patient's ability to sleep.
- **Reliable:** Enhanced quality and reliability (<100 ppm) reduce downtime in many demanding operations.



HAF Series



AWM90000 Series



## Flexible Heater Assemblies in Sleep Apnea Machines

A3100 Series, A3200 Series, A3400 Series, C3100 Series, C3200 Series, C3400 Series

A flexible heater is often required to warm water to vapor in the pump area to increase humidity so that a comfortable breathing environment can be provided to the patient. There are other ways of generating water vapor, such as misting valves, but using heat ensures a uniform, warm, and moist breathing experience most preferred by patients. The heat is generally controlled by an onboard negative temperature coefficient (NTC) thermistor offering variable air temperature that, depending on the OEM, can adjust the vapor/air temperature to improve patient comfort.

### Benefits to Customer

- **Customizable:** Capability to quickly customize flexible heater building block technology meets custom application requirements.
- **Eases system qualification:** Meets regulatory requirements, easing system qualification.
- **Flexible:** Numerous configurations (e.g., flat, molded-to-shape, spiral wrap, transparent, composite, and high-temperature),

a variety of manufacturing materials (e.g., silicone and other flexible dielectric components) and various watt densities (e.g., single, multiple, or variable) increase application flexibility.

- **Improves patient's comfort:** Integration of mounting and sensing components allows for the desired vaporization of water, enhancing patient comfort.
- **Improves patient's safety:** Built-in temperature-detection device helps minimize overheating, improving patient safety.
- **Stable:** Minimizes heat loss by maintaining a uniform temperature.



3100 Series



3200 Series



3400 Series

## Magnetic Position Sensors ICs in Sleep Apnea Machines

SS400 Series

Magnetic position sensor ICs are designed to provide enhanced output accuracy for smooth motor control that reduces noise and vibration in potential applications that include sleep apnea machine motor assembly fan systems. Their small size allows for design into many compact, automated, lower-cost assemblies. A thermally-balanced integrated circuit that is accurate over a full temperature range is designed to provide proper fan functionality.

### Benefits to Customer

- **Accurate:** Enhanced accuracy and linearity over-span of 0~5 V output enables an extended sensing range.
- **Circuit protection:** Reverse voltage and polarity protection provides circuit protection.
- **Cost-effective:** Small sensor size allows for compact designs and automated, lower-cost assemblies.

- **Effective:** Thermally-balanced integrated circuit that is accurate over the full temperature range enhances proper fan function.
- **Energy-efficient:** Low power consumption enhances energy efficiency.
- **Quiet:** Industry-leading sensor output accuracy for smooth motor control enables low audible noise and reduces motor vibration.



SS400 Series

## Humidity Sensors in Sleep Apnea Machines

Honeywell HumidCon™ HIH6130/6131 Series, HIH-4000 Series, HIH-4020/4021 Series, HIH-4030/4031 Series, HIH-5030/5031 Series, HCH-1000 Series

Humidity sensors monitor the amount of humidified air with accurate dew-point and absolute humidity/moisture measurement to provide a desired amount of air moisture to the patient, enhancing patient comfort to help provide uninterrupted sleep. Used in all three types of PAP machines.

### Benefits to Customer

- **Industry-leading long term stability (1.2 RH% over 5 years):** Minimizes system performance issues, helps support system uptime, and eliminates the need to recalibrate the sensor in the application (Honeywell HumidCon™).
- **Industry-leading Total Error Band (TEB) ( $\pm 5$  %RH):** Provides the sensor's true accuracy reducing manufacturing time, supports system warranty requirements, helps optimize system uptime, and provides excellent sensor interchangeability (Honeywell HumidCon™).
- **Lowest total cost solution:** Offers customers the lowest total cost solution due to the sensor's industry-leading Total Error Band and being a combined humidity/temperature sensor (Honeywell HumidCon™).
- **Accurate:** Enhanced stability, accuracy, and response time over the entire humidity range of 0~100% RH supports demanding system performance requirements, even in many condensing environments.

- **Cost-effective:** Surface mount device (SMD) packaging on tape and reel allows for use in automated, high-volume, lower-cost pick-and-place manufacturing.
- **Durable:** Multi-layer construction and a hydrophobic filter provides enhanced resistance to condensation and contaminants.
- **Flexible:** Its small, space-saving housing profile allows for application flexibility. Its low current draw allows for use in low-current-drain, battery-operated systems.



## Pressure Sensors in Sleep Apnea Machines

Board Mount Pressure Sensors: TruStability® (HSC Series, SSC Series)

Honeywell's TruStability® board mount pressure sensors monitor the pressure of air that is delivered to the patient in a variety of potential applications, including all three types of Positive Air Pressure (PAP) machines.

### Benefits to Customer

- **Accurate:** TruStability® sensors' exceptional accuracy is a result of leading-edge technology, precise manufacturing processes and temperature compensation and calibration. TruStability® sensors have two levels of accuracy: the standard accuracy SSC Series offers  $\pm 2\%$  total error band, and the HSC Series offers  $\pm 1\%$  total error band, better than most competitive products.
- **Efficient:** The customer can monitor pressure within the specified range and adjust as needed, helping to prevent the airway from temporarily collapsing, improving the patient's ability to sleep and enhancing the efficacy of treatment.

- **Reliable:** Enhanced quality and reliability (<100 ppm) provides enhanced reliability in many demanding operations.
- **Sensitive:** Customized and calibrated to the customer's desired pressure range, providing enhanced sensitivity.
- **Stable:** Stability is a measure of how little the output signal of the pressure sensor will change from measurement to measurement. The long-term stability of Honeywell's TruStability® sensors is the best in the industry.



TruStability® HSC Series, SSC Series

## Thermostats in Sleep Apnea Machines

### 2450RC Series

Bimetallic commercial thermostats may be included in sleep apnea machines as on-board (stand-alone) devices on flexible heaters for temperature control without the need to add associated software or electronics.

#### Benefits to Customer

- **Customizable:** Custom operating temperatures and tolerances fit customer-specific applications.

- **Flexible:** Wide variety of mounting brackets and terminals increase flexibility of use within the application.
- **Small:** Small product size often eases use in confined spaces.



2450RC Series

## Thermistors and Pre-Packaged Temperature Probes in Sleep Apnea Machines

### 192 Series, 194 Series Thermistor Temperature Sensors; 500 Series Pre-Packaged Temperature Probes

Air from sleep apnea machines that is warm and moist helps to provide the patient with a comfortable breathing situation and may reduce sore throats caused by breathing cold, dry air. As such, the temperature of the air delivery system is often monitored and controlled to provide an air stream at a desired level of warmth. Temperature sensors are installed directly into the air stream and are designed to monitor the air temperature.

#### Benefits to Customer

##### 192 Series, 194 Series Thermistor Temperature Sensors

- **Accurate and stable**
- **Cost-effective:** Resistance temperature matched interchangeable units designed to provide cost savings by eliminating need for individual resistance temperature calibration and standardization of circuit components.
- **Simple:** Designed to simplify design and replacement in

temperature measurement, indication, control, and compensation of ambient temperature effects on a variety of integrated circuits and other semiconductor devices.

- **Small:** Small size often eases use in confined spaces.

##### 500 Series Pre-Packaged Probes

- **Accurate:** Directs thermal or fluid flow evenly across thermistors for accurate temperature sensing.
- **Effective design:** Protects the thermistors against damage in use or handling.
- **Flexible:** Wide operating temperature range [60 °C to 300 °C / -76 °F to 572 °F] provides application flexibility. Wide selection of housing, resistance, and termination options provides application flexibility. Housing material ranges from all plastic to all metal, and accommodates air/gas, fluid immersion, or surface sensing requirements.



192 Series

194 Series



500 Series

## Sleep Apnea Machine Block Diagram

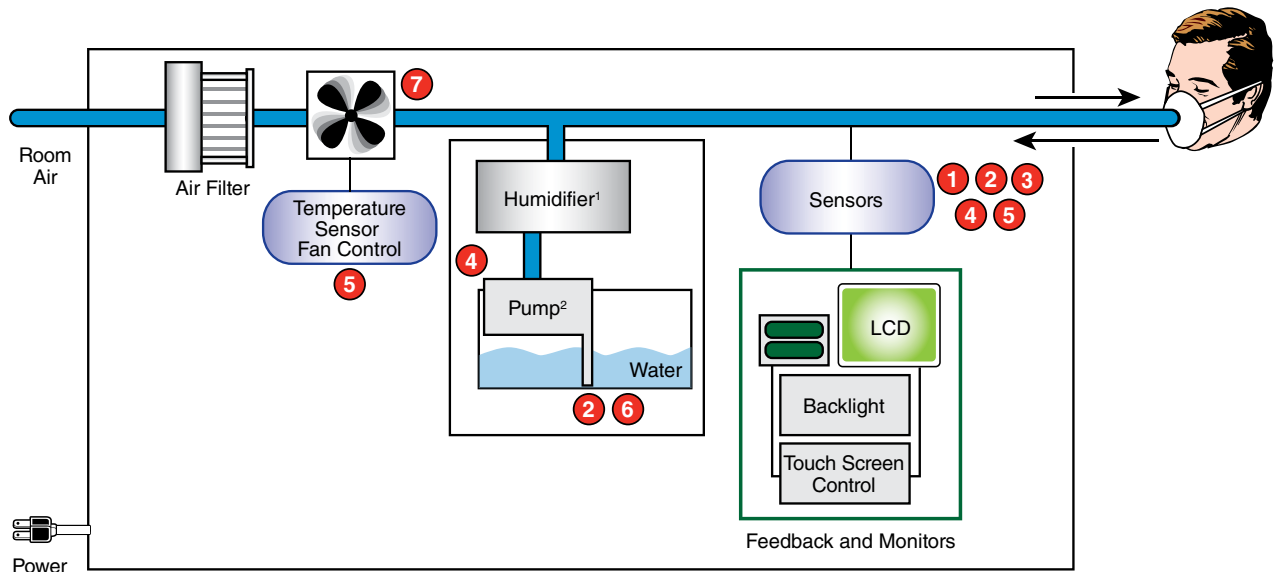

**1 Airflow Sensors\***  
Honeywell Zephyr™  
HAF Series or AWM90000 Series (AWM92100V)

**2 Flexible Heater Assembly**

**3 Humidity Sensors**  
HIH Series or HCH Series

**4 Low Pressure Board Mount Pressure Sensors**  
TruStability® HSC Series, SSC Series

**5 Discrete Thermistors**  
192 Series or 194 Series

or

**Packaged Temperature Probes**  
500 Series

**6 Commercial Thermostats**  
2450RC Series

**7 Magnetic Sensor ICs**  
SS400 Series

\* Typically there is only one airflow sensor per machine. Some customers place it before the blower and some after the blower.

<sup>1</sup> Humidifier may be designed in house or purchased from a third party.

<sup>2</sup> Some CPAP machines may not utilize a pump.





## Respiratory: Ventilators

A ventilator is designed to move a mixture of air and oxygen into and out of a patient's lungs to either assist in breathing or, in some cases, do the mechanical breathing for a patient who is breathing insufficiently or is physically unable to breathe.

### Sensor Solutions for Ventilators

- Airflow Sensors**
- Flexible Heater Assemblies**
- Magnetic Position Sensor ICs**
- Humidity Sensors**
- Pre-packaged Temperature Probes**
- Pressure Sensors/Transducers**
- Thermistors**

### Airflow Sensors in Ventilators

#### Honeywell Zephyr™ HAF Series

Honeywell Zephyr™ Airflow Sensors are designed to measure the flow of air, oxygen, and nitrous oxide. They may be used so that the desired mixture, as set by the doctor, is delivered to the patient. The total mixture that is delivered to the patient is also measured and is displayed on the ventilator panel.

#### Benefits to Customer

- **High 2.5% accuracy:** Allows for very precise airflow measurement, often ideal for demanding applications with high accuracy requirements.

- **Customizable:** Allows the sensor to be designed to meet specific end-user needs.
- **High sensitivity at very low flows:** Allows the customer's application to detect presence or absence of airflow.
- **High stability:** Reduces errors due to thermal effects and null shift to provide accurate readings over time, often eliminating need for system calibration after printed circuit board (PCB) mount and periodically over time.
- **Low pressure drop:** Low pressure drop typically improves patient comfort in medical applications, and reduces noise

and system wear in components such as motors/pumps.

- **Saves customers time and money:** Linear output provides a more intuitive sensor signal than the raw output of basic airflow sensors, often eliminating the need for customers having to linearize the output which can help to reduce production and design costs and implementation time.



HAF Series

### Flexible Heater Assemblies in Ventilators

#### A3100 Series, A3200 Series, A3400 Series, C3100 Series, C3200 Series, C3400 Series

A flexible heater is often required to vaporize water so that a comfortable breathing environment can be provided to the patient. There are other ways of generating water vapor, such as misting valves, but using heat ensures a uniform, warm, and moist breathing experience most preferred by patients. The heat is generally controlled by an onboard negative temperature coefficient (NTC) thermistor offering variable air temperature that, depending on the OEM, can adjust the vapor/air temperature to improve patient comfort.

#### Benefits to Customer

- **Customizable:** Capability to quickly customize flexible heater building block technology to meet application requirements.
- **Eases patient's comfort:** Integration of mounting and sensing components allows for the desired vaporization of water, enhancing patient comfort.
- **Eases system qualification:** Meets regulatory requirements, easing system qualification.
- **Flexible:** Numerous configurations (e.g., flat, molded-to-shape, spiral wrap, transparent, composite, and high-temperature), a variety of manufacturing materials (e.g., silicone and other flexible dielectric components) and various watt

densities (e.g., single, multiple, or variable) increase application flexibility.

- **Safe:** Built-in temperature-detection device helps minimize overheating, improving patient safety.
- **Stable:** Minimizes heat loss by maintaining a uniform temperature.



3100 Series



3200 Series



3400 Series

## Magnetic Position Sensor ICs in Ventilators

### SS400 Series

Magnetic position sensor ICs are designed to provide enhanced output accuracy for smooth motor control that reduces noise and vibration in many potential applications, including ventilator motor assembly fan systems. Their small size often allows for design into many compact, automated, lower-cost assemblies. A thermally-balanced integrated circuit that is accurate over a full temperature range is designed to provide proper fan functionality.

#### Benefits to Customer

- **Accurate:** Enhanced accuracy and linearity over-span of 0~5 V output enables an extended sensing range.
- **Circuit protection:** Reverse voltage/polarity protection provides circuit protection.
- **Cost-effective:** Small sensor size allows for compact designs and automated, lower-cost assemblies.
- **Effective:** Thermally-balanced integrated circuit enhances proper fan function.

- **Energy-efficient:** Low power consumption enhances energy efficiency.
- **Quiet:** Industry-leading sensor output accuracy for smooth motor control enables low audible noise and reduces motor vibration.



SS400 Series

## Humidity Sensors in Ventilators

### Honeywell HumidCon™ HIH6130/6131 Series, HIH-4000 Series, HIH-4020/4021 Series, HIH-4030 Series, HIH-4602 Series, HIH-5030/5031 Series, HCH-1000 Series

Honeywell's humidity sensors help deliver warm and moist air, which often enhances patient comfort. When introducing moisture into the air stream of a ventilator, it must be monitored and controlled. Honeywell's humidity sensors are installed either directly into the air stream or in a parallel branch. The sensor is coupled to a microcontroller designed to measure the humidity of the air stream and to signal the controller that the desired level of moisture is present.

#### Benefits to Customer

- **Industry-leading long term stability (1.2 RH% over 5 years):** Minimizes system performance issues, helps support system uptime, and eliminates

the need to recalibrate the sensor in the application (Honeywell HumidCon™).

- **Industry-leading Total Error Band (TEB) ( $\pm 5\%$  RH):** Provides the sensor's true accuracy reducing manufacturing time, supports system warranty requirements, helps optimize system uptime, and provides excellent sensor interchangeability (Honeywell HumidCon™).
- **Lowest total cost solution:** Offers customers the lowest total cost solution due to the sensor's industry-leading Total Error Band and being a combined humidity/temperature sensor (Honeywell HumidCon™).
- **Accurate:** Enhanced stability, accuracy,

and response time over the entire humidity range of 0~100% RH supports demanding system performance requirements, even in many condensing environments.

- **Cost-effective:** Surface mount device (SMD) packaging on tape and reel allows for use in automated, high-volume, lower-cost pick-and-place manufacturing.
- **Durable:** Multi-layer construction and a hydrophobic filter provides enhanced resistance to condensation and contaminants.
- **Flexible:** Small, space-saving housing profile allows for application flexibility; utilizing a low current draw allows for use in low-current-drain, battery-operated systems.



HumidCon™  
HIH 6130/6131 Series



HIH-4000  
Series

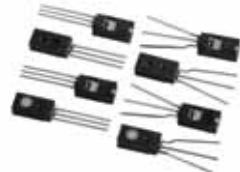

HIH-4020/4021  
Series



HIH-4030  
Series



HIH-4602  
Series



HIH-5030/5031  
Series



HCH-1000  
Series

## Pre-Packaged Temperature Probes

### 500 Series

Pre-packaged temperature probes perform the same function in this application as thermistors (monitor air temperature).

#### Benefits to Customer:

- **Flexible:** Wide selection of housing, resistance, and termination options.
- **Customizable:** Variety of custom or off-the-shelf products available.



500 Series

## Pressure Sensors/Transducers in Ventilators

**Board Mount Pressure Sensors: TruStability® (HSC Series, SSC Series), ASDX Series, CPC Series (CPCL10GFC), SDX Series (SDX010IND4); Heavy Duty Pressure Sensors/Transducers: MLH Series, 19 mm Series, SPT Series**

Honeywell's TruStability® and ASDX Series board mount pressure sensors are designed to measure air and oxygen pressure so that the pressure doesn't exceed a desired level. The CPC Series and the SDX Series may also be used with a customer-provided amplifier or ASIC-based solution for a signal conditioned output. The MLH Series, 19 mm Series, and SPT Series heavy duty pressure sensors/transducers are designed to provide a sensing solution when high pressure, steel pressure port interface, and/or corrosive media are used. A male threaded pressure port and stainless steel wetted surfaces provide an air and oxygen inlet.

### Benefits to Customer

- **Accurate:** Enhances patient safety by measuring volume and mixture of gases to deliver the mixture at a desired pressure and flow.

- TruStability® sensors' exceptional accuracy is a result of leading-edge technology, precise manufacturing processes, and temperature compensation and calibration. TruStability® sensors have two levels of accuracy: the standard accuracy SSC Series offers  $\pm 2\%$  total error band, and the HSC Series offers  $\pm 1\%$  total error band, better than most competitive products.
- ASDX Series offers accuracy of  $\pm 2\%$ .
- MLH Series' accuracy depends upon the pressure range: above 300 psi 0.25% FSS; below 300 psi 0.5% FSS; 19 mm Series offers 0.25% FSS; SPT Series offers 0.25% FSS.

- **Compatible:** Wetted materials or media isolated packaging (materials resistant to certain contaminants or media) offer compatibility with many harsh environments and resistance to certain contaminants.

- **Easy to design in:** Customization of pressure ranges, connections, calibration, and temperature compensation minimize customer's design-in effort.
- **Easy to use:** Small package with integrated signal conditioning reduces the number of components needed to implement the sensor, enabling size reduction of the end product.
- **Safe:** Enhanced accuracy, sensitivity, and stability with minimal drift over time and temperature enhances patient safety and therapy effectiveness by sensing when patient is breathing on own to wean off the device.
- **Stable:** Stability is a measure of how little the output signal of the pressure sensor will change from measurement to measurement. The long-term stability of Honeywell's TruStability® sensors is the best in the industry.



TruStability® HSC Series, SSC Series



ASDX Series



CPC Series



SDX Series



MLH Series



19 mm Series



SPT Series

## Thermistors in Ventilators

**192 Series, 194 Series**

Air from ventilators that is warm and moist helps to provide the patient with a comfortable breathing situation and may reduce sore throats caused by breathing cold, dry air. As such, the temperature of the air delivery system is often monitored and controlled to provide an air stream at a desired level of warmth. Discrete thermistor temperature sensors are installed directly into the air stream and are designed to monitor the air temperature. The sensor is coupled to a microcontroller designed to measure air

stream temperature and interact with the controller which controls and regulates the temperature of the air stream. Honeywell offers several types of configurations. The packaged sensors are available as discrete components for customer-built assemblies, or Honeywell can provide a full assembly solution that the customer may simply pigtail into the system.

### Benefits to Customer

- **Cost-effective:** Resistance temperature curve interchangeability designed to

offer standardization of circuit components and simplification of design/replacement enhances cost-effectiveness.

- **Flexible:** Bare leads (192 Series) or insulated leads (194 Series) are designed to provide application flexibility.
- **Small:** Small size often eases use in confined spaces.



192 Series



194 Series

# Ventilator Block Diagram

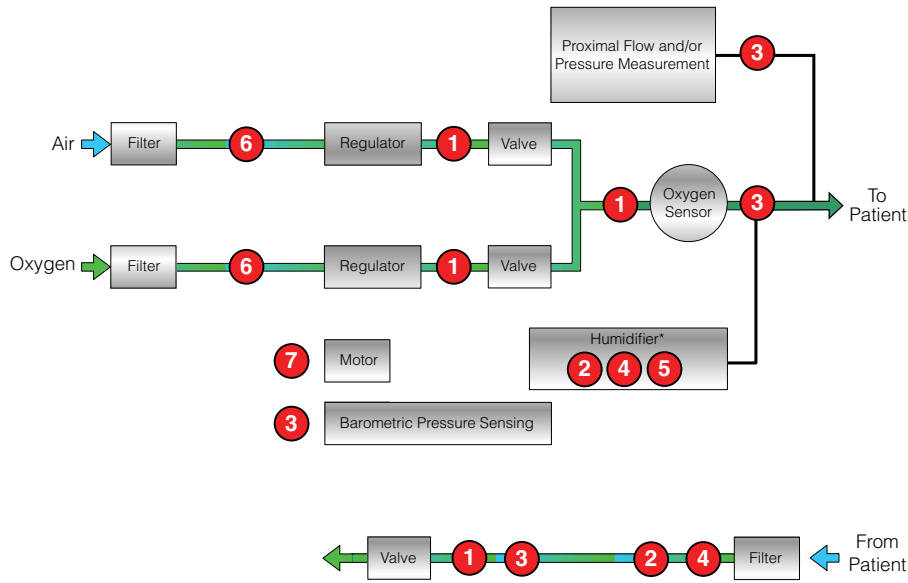

- 1 Airflow Sensors**  
Honeywell Zephyr™  
(HAF Series)
- 2 Discrete Thermistor Temperature Sensors**  
192 Series or 194 Series  
or  
**Packaged Temperature Probes**  
500 Series
- 3 Low Pressure Board Mount Pressure Sensors**  
TruStability®  
(HSC Series or SSC Series)  
or  
**Ultra-Low Pressure Board Mount Pressure Sensors**  
ASDX Series
- 4 Flexible Heater Assembly**  
Custom Configuration
- 5 Humidity Sensors**  
HIH Series
- 6 Heavy Duty Pressure Sensors/Transducers**  
MLH Series or 19 mm Series or SPT Series
- 7 Magnetic Sensor ICs**  
SS400 Series







# Kidney Dialysis Machines

Kidney dialysis machine treatments replace some kidney functions by removing waste and fluid from the bloodstream via diffusion and osmosis of solutes and fluid across a semi-permeable dialysis membrane. Blood in one compartment is pumped along one side of the membrane while a dialysate (a crystalloid solution that acts as a sponge for impurities) is pumped along the other side, in a separate compartment, in the opposite direction. Ultra filtration occurs by increasing the hydrostatic pressure across

the membrane by applying a negative pressure to the dialysate compartment of the dialyzer. This pressure gradient causes water and dissolved solutes to move from the blood to the dialysate. The cleansed blood returns via the circuit back to the body. Honeywell manufactures many sensors that may be used in kidney dialysis machines. They provide presence and absence detection, and pressure, flow, and temperature measurement.

## Sensor Solutions for Kidney Dialysis Machines

- Flexible Heater Assemblies**
- Force Sensors**
- Magnetic Position Sensor ICs**
- Infrared Sensors**
- Pressure Sensors/Transducers**
- Thermistors**

## Flexible Heater Assemblies in Kidney Dialysis Machines

**A3100 Series, A3200 Series, A3400 Series, C3100 Series, C3200 Series, C3400 Series**

Honeywell's flexible heater assemblies are designed to provide controlled heat for warming blood or dialysate to body temperature prior to re-entry into the body. This may be accomplished by either heat exchange (constant temperature bath) or direct heat through warming plates. These flexible heater assemblies are custom-designed to customer requirements. Other components, such as NTC thermistors, RTDs, or solid state temperature sensors, may be added for temperature monitoring and control.

### Benefits to Customer

- **Customizable:** Capability to quickly customize flexible heater building block technology to meet custom application requirements.
- **Eases system qualification:** Meets regulatory requirements, easing system qualification.
- **Flexible:** Numerous configurations (e.g., flat, molded-to-shape, spiral wrap, transparent, composite, and high-temperature), a variety of manufacturing materials (e.g., silicone and other flexible dielectric components) and various watt densities (e.g., single, multiple, or variable) increase application flexibility.

- **Safe:** Built-in temperature-detection device helps minimize overheating, improving patient safety.
- **Stable:** Minimizes heat loss by maintaining a uniform temperature.



3100 Series



3200 Series



3400 Series

## Force Sensors in Kidney Dialysis Machines

### 1865 Series, FS Series

Honeywell's 1865 Series and FS Series force sensors may be used to detect the presence or absence of a fresh dialysate cartridge before the dialysis machine can be used. These sensors are used in a non-invasive manner and require no disinfection or sterilization before reuse. Other potential uses for Honeywell's force sensors include monitoring the flexible tubing pressure of the dialysate to detect whether the pressure exceeds a specified

level, and monitoring the weight of the dialysate to detect whether there is a sufficient amount of dialysate in the fresh dialysate cartridge.

#### Benefits to Customer

- **Reliable:** Enhanced quality and reliability (<100 ppm).
- **Sensitive:** Enhanced sensitivity to force changes enables early detection of occlusion, enhancing patient safety.

- **Stable:** Ability to detect occlusion accurately over time provides enhanced stability and low drift.



1865 Series

FS Series

## Magnetic Position Sensor ICs in Kidney Dialysis Machines

### SS400 Series

Magnetic position sensor ICs are designed to provide reliable, accurate output for smooth motor control that reduces noise and vibration in the machine's motor assembly and improves its efficiency. Their solid state reliability often reduces repair and maintenance costs, and its small size allows for design into many compact, automated, lower-cost assemblies. A thermally-balanced integrated circuit provides consistent operation over the full temperature range.

#### Benefits to Customer

- **Accurate:** For linear displacement and current sensing, analog Hall-effect sensors provide accurate and linear output over-span of 0~5 V, enabling an extended sensing range.
- **Cost-effective:** Small sensor size allows for compact designs and automated, lower-cost assemblies and minimizes replacement costs.
- **Energy-efficient:** Hall-effect sensors

consume little energy and help improve motor efficiency.

- **Quiet:** Reliable, accurate sensor output for smooth motor control enables low audible noise, and reduces motor vibration.



SS400 Series

## Infrared Sensors in Kidney Dialysis Machines

### HOA088X Series, HOA698X Series

Honeywell's infrared sensors are designed to be used with an encoder wheel on the pump shaft to count shaft rotation. They contain an infrared emitter and a photo detector that are mounted facing each other inside a plastic housing. Detection occurs when an opaque object passes through the package slot, interrupting the infrared path.

#### Benefits to Customer

- **Enables maximum position resolution:** Lead wires provide alternate electrical connection when PC board mounting is not possible, often ideal for use in potential applications in which maximum position resolution is desired.

- **Operates in contaminated environments:** Infrared transmissive polysulfone housing features smooth optical faces without external aperture openings, desirable when aperture blockage from airborne contaminants is a possibility.
- **Reliable:** Reliability is enhanced by the following: all solid-state design; low power consumption; no moving parts; built-in strain relief for maximum wire attachment strength; PC board mount is available.

- **Numerous options:** Variety of package styles, optical aperture sizes, and mounting options; analog and digital outputs (digital output options are 10K pull-up, open collector or totem-pole with inverting or non-inverting options).



HOA088X Series



HOA698X Series

## Pressure Sensors/Transducers in Kidney Dialysis Machines

**Board Mount Pressure Sensors: TruStability® (HSC Series, SSC Series), 26PC Flow-Through Series (26PCFEP5G40)**

**Heavy Duty Pressure Sensors/Transducers: 13 mm Series, 19 mm Series, SPT Series**

Honeywell's TruStability® and 26PC Series flow-through board mount pressure sensors are designed to provide enhanced reliability and may be used to obtain a direct, in-line continuous dialysate and venous pressure measurement in the dialysis membrane without interrupting flow. The easy-to-sterilize package eliminates the need for an additional pressure tap and/or manifold, minimizing the unused space in the flow measurement path, which helps to prevent bacteria contamination and simplifies sterilization. The 13 mm Series, 19 mm Series, and SPT Series heavy duty pressure sensors/transducers, when located in a fresh dialysate cartridge, may be used to monitor pressure in the flexible tubing that carries blood or dialysate to provide continuous feedback of line pressures and pump control. These sensors may also be used to perform the same function as the 26PC Flow-Through Series in the dialysis membrane.

### Benefits to Customer

- **Accurate:** Provides stable performance with low drift over time, allowing accurate pressure monitoring of fluid and blood flow to help maintain the pressure in the desired range, improving treatment efficiency and reducing the time it takes to remove fluid from the peritoneum. TruStability® sensors'

exceptional accuracy is a result of leading-edge technology, precise manufacturing processes and temperature compensation and calibration. TruStability® sensors have two levels of accuracy: the standard accuracy SSC Series offers  $\pm 2\%$  total error band, and the HSC Series offers  $\pm 1\%$  total error band, better than most competitive products. Honeywell's 26PC Flow-Through Series offers  $\pm 2\%$ ; 13 mm Series, 19 mm Series, and SPT Series offer 0.25% FSS.

- **Easy to design in:** Customization with desired pressure ranges, connections, calibration, and temperature compensation minimizes customer's design-in effort.
- **Extended life:** Product availability throughout the customer's product lifecycle minimizes the need to repeat the design-in process and requalifying/resubmitting for regulatory approval.
- **Small:** Small package reduces the number of components needed to implement the sensor, enabling reduction in size and weight.
- **Stable:** Stability is a measure of how little the output signal of the pressure sensor will change from measurement to measurement. The long-term stability of Honeywell's TruStability® sensors is the best in the industry.



TruStability® HSC Series,  
SSC Series



26PC Flow-Through  
Series



13 mm Series



19 mm Series



SPT Series

## Thermistors in Kidney Dialysis Machines

**192 Series, 194 Series**

Temperature directly affects the permeation rate across the dialysis membrane. The 192 and 194 Series discrete thermistor temperature sensors provide temperature measurement for enhanced control of this variable. The sensor is coupled to a microcontroller designed to monitor the temperature of the operation and to interact with the controller to help regulate the temperature of the system. Honeywell offers several configurations. These packaged sensors are available as discreet components for custom-built assemblies, as well as full assembly solutions that the customer may simply pigtail into the system.

### Benefits to Customer

- **Cost-effective:** Resistance temperature curve interchangeability designed to offer standardization of circuit components and simplification of design/replacement enhances cost-effectiveness.
- **Flexible:** Bare leads (192 Series) or insulated leads (194 Series) are designed to provide application flexibility.
- **Small:** Small size often eases use in confined spaces.



192 Series



194 Series

## Kidney Dialysis Machine Block Diagram

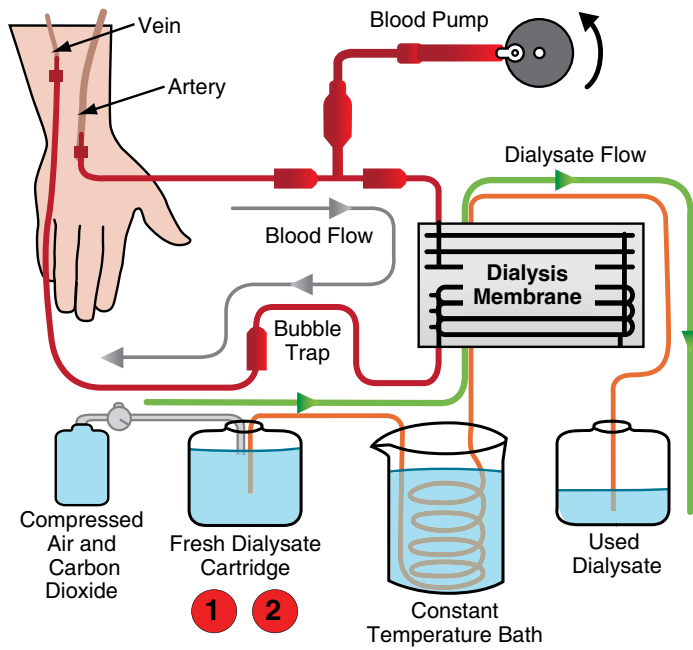

- 1 Force Sensors**  
1865 Series,  
FS Series
- 2 Heavy Duty Pressure Sensors/Transducers**  
13 mm Series,  
19 mm Series,  
SPT Series

## Dialysis Membrane Detail

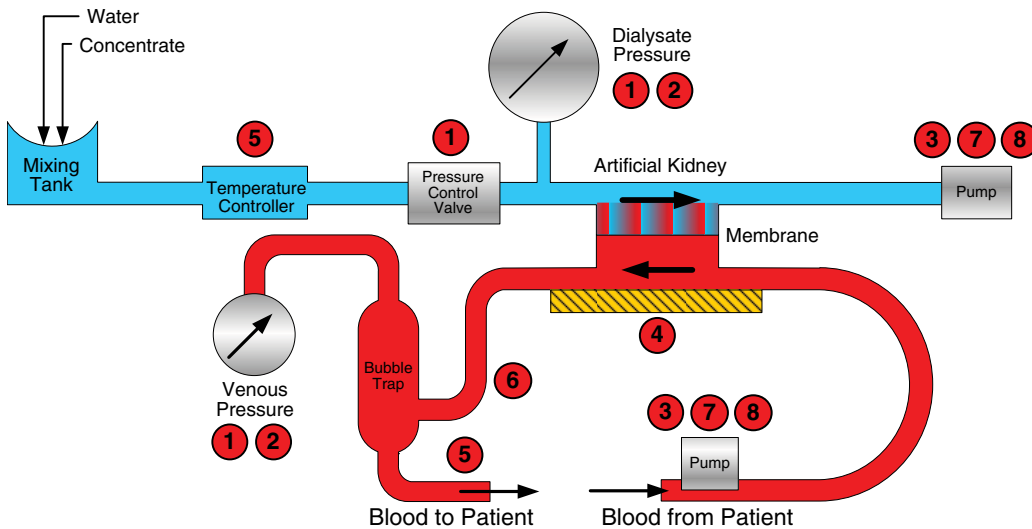

- 1 Low Pressure Board Mount Pressure Sensors**  
TruStability® (HSC Series, SSC Series)  
26PC Flow-Through Series
- 2 Heavy Duty Pressure Sensors/Transducers**  
13 mm Series, 19 mm Series, SPT Series
- 3 Magnetic Sensor ICs**  
SS400 Series
- 4 Flexible Heater Assemblies**  
A3100 Series, C3100 Series, A3200 Series,  
C3200 Series, A3400 Series, or C3400 Series  
Custom Configuration
- 5 Discrete Thermistor Temperature Sensors**  
192 Series, 194 Series
- 6 Force Sensors**  
FS Series
- 7 Transmissive Infrared Sensors**  
HOA088X
- 8 Optoschmitt (Transmissive) Infrared Sensors**  
HOA698X





# Infusion, Insulin, and Syringe Pumps



An infusion, insulin, or syringe pump—typically a screw pump that pushes on a syringe or cartridge—is used to deliver small amounts of medication to a patient intravenously.

## Sensor Solutions for Infusion, Insulin, and Syringe Pumps

- Flexible Heater Assemblies
- Force Sensors
- Magnetic Position Sensor ICs
- Infrared Sensors
- Pressure Sensors

## Flexible Heater Assemblies in Infusion Pumps

### A3400 Series, C3400 Series

Honeywell's flexible heater assemblies are designed to conform to the infusion pump's surface that requires heating. They are capable of maintaining specific temperatures at desired levels.

#### Benefits to Customer

- **Application flexibility:** Numerous configurations (e.g., flat, molded-to-shape, spiral wrap, transparent, composite, and high-temperature), a variety of manufacturing materials (e.g., silicone and other flexible dielectric components) and various watt densities (e.g., single, multiple, or variable) increase application flexibility.
- **Customizable:** Capability to quickly customize flexible heater building block technology meets custom application requirements.

- **Eases system qualification:** Meets regulatory requirements, easing system qualification.
- **Improves patient's safety:** Built-in temperature-detection device helps minimize overheating, improving patient safety.
- **Stable:** Minimizes heat loss by maintaining a uniform temperature.



3400 Series

## Force Sensors in Infusion, Insulin Pumps, and Syringe Pumps

FSS Series, FS01/FS03 Series, FSG Series, 1865 Series (Infusion Pumps); FSS Series (Insulin Pumps)

Honeywell's force sensors provide an occlusion detector to ensure there isn't a blockage in the infusion or insulin pump's tube that delivers the medication to the patient. If the tube becomes blocked, the force sensor alerts the patient, nurse, or doctor via an audible alarm that the therapy isn't being delivered.

### Benefits to Customer

- **Easy to use:** Sensor is external to the tubing (media isolated), minimizing the need for the tubing to be sterilized or re-sterilized after each use.
- **Portable:** Sensor's small size and low power consumption improves the patient's quality of life due to the increased portability of the end product and longer battery life (FSS Series).

- **Reliable:** Enhanced quality and reliability (<100 ppm) provides enhanced reliability in many demanding operations.
- **Sensitive:** Enhanced sensitivity to force changes enables early detection of occlusion, enhancing patient safety.
- **Stable:** Ability to detect occlusion accurately over time provides enhanced stability and low drift.



## Magnetic Position Sensor ICs in Infusion and Insulin Pumps

SL353 Series, SS400 Series

The Hall-effect magnetic position sensor is designed to provide reliable, accurate output for smooth motor control that reduces noise and vibration in the pump's motor assembly and improves its efficiency. Its solid state reliability often reduces repair and maintenance costs, and its small size allows for design into many compact, automated, lower-cost assemblies. A thermally-balanced integrated circuit provides consistent operation over the full temperature range.

### Benefits to Customer

- **Energy efficient:** Hall-effect sensors consume little energy and help improve motor efficiency. The SL353 Series' supply voltage (as low as 2.2 Vdc) combined with very low average current reduces power consumption and provides extended battery life.
- **Push-pull output does not require external pull-up resistor:** Simplifies interface with common electrical circuits and potentially reduces PC board space and costs to the customer (SL353 Series).

- **Non-chopper stabilized design:** Does not utilize chopper stabilization, eliminating noise generated by products using this technique (SL353 Series).
- **Accurate:** For linear displacement and current sensing, analog Hall-effect sensors provide accurate and linear output over-span of 0~5 V, enabling an extended sensing range.
- **Cost-effective:** Small sensor size allows for compact designs and automated, lower-cost assemblies and minimizes replacement costs.
- **Quiet:** Reliable, accurate sensor output for smooth motor control enables low audible noise, and reduces motor vibration.



## Infrared Sensors in Infusion, Insulin, and Syringe Pumps

HOA088X Series, HOA698X Series

Honeywell's infrared sensors are designed to be used with an encoder wheel on the pump shaft to count shaft rotation. They contain an infrared emitter and a photo detector that are mounted facing each other inside a plastic housing. Detection occurs when an opaque object passes through the package slot, interrupting the infrared path.

### Benefits to Customer

- **Enables maximum position resolution:** Lead wires provide alternate electrical connection when PC board mounting is not possible, often ideal for use in potential applications in which maximum position resolution is desired.
- **Operates in contaminated environments:** Infrared transmissive polysulfone housing features smooth optical faces without external aperture openings, often desirable when

aperture blockage from airborne contaminants is a possibility.

- **Reliable:** Reliability is enhanced by the following: all solid-state design; low power consumption; no moving parts; built-in strain relief for maximum wire attachment strength; PC board mount is available.
- **Robust:** Variety of package styles, optical aperture sizes, and mounting options; analog and digital outputs (digital output options are 10K pull-up, open collector or totem-pole with inverting or non-inverting options).



## Pressure Sensors in Infusion, Insulin, and Syringe Pumps

### Board Mount Pressure Sensors: TruStability® (HSC Series, SSC Series)

Honeywell's TruStability® board mount pressure sensors may be used to monitor and control the flow of fluid.

#### Benefits to Customer

- **Accurate:** Provides stable performance with low drift over time, allowing accurate pressure monitoring of fluid flow to help maintain the pressure in the desired range, improving treatment efficiency. TruStability® sensors' exceptional accuracy is a result of leading-edge technology, precise manufacturing processes and temperature compensation and calibration. TruStability® sensors have two levels of accuracy: the standard accuracy SSC Series offers  $\pm 2\%$  total error band, and the HSC Series offers  $\pm 1\%$  total error band, better than most competitive products.
- **Easy to design in:** Customization with desired pressure ranges, connections, calibration, and temperature compensation minimizes customer's design-in effort.

- **Stable:** Stability is a measure of how little the output signal of the pressure sensor will change from measurement to measurement. The long-term stability of Honeywell's TruStability® sensors is the best in the industry.



TruStability® HSC Series,  
SSC Series

## Infusion Pump Block Diagram

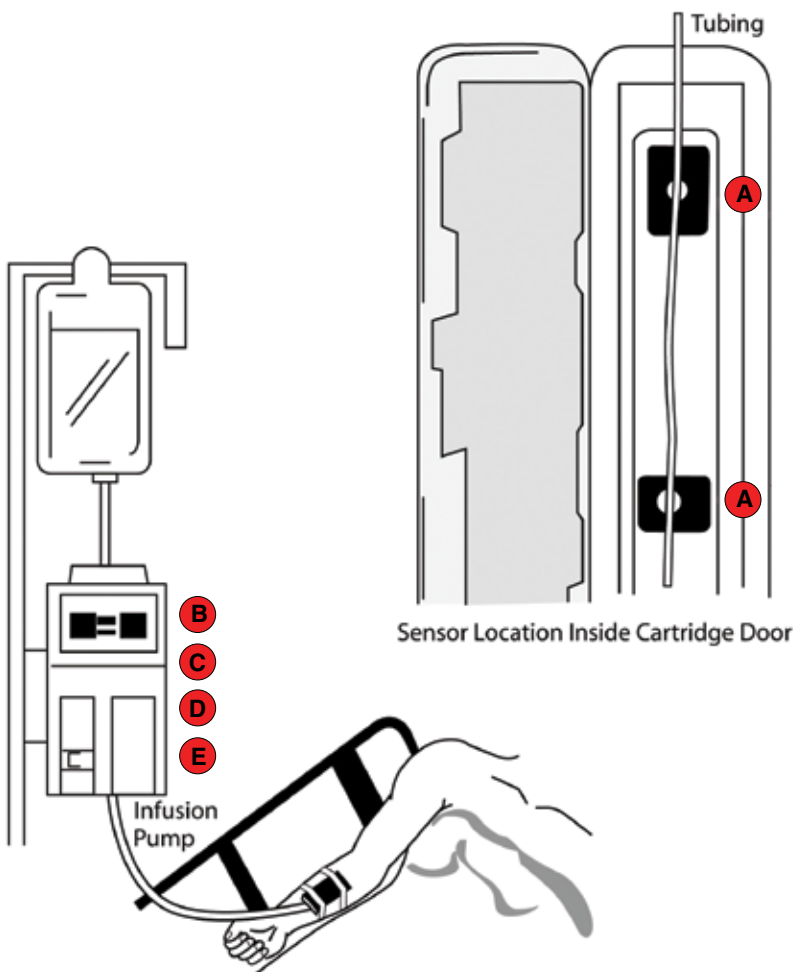

- A Force Sensors**  
FSS Series, FSG Series,  
1865 Series, FS01/FS03 Series
- B Board Mount Pressure Sensors**  
TruStability® (HSC Series, SSC Series)
- C Flexible Heater Assemblies**  
A3400 Series, C3400 Series
- D Magnetic Sensor ICs**  
SS400 Series
- E Infrared Sensors**  
HOA088X Series, HOA698X Series



# Diagnostics/Analytical Equipment

Honeywell offers a broad sensor portfolio for a variety of diagnostic and analytical equipment applications, including blood analyzers, hematology analyzers, immunoassay analyzers, clinical chemistry analyzers, mass spectrometers, chromatography (gas, liquid, HPLC), and lab automation systems.

## Sensor Solutions for Diagnostics/Analytical Equipment

### Blood Analyzers

- Infrared Sensors
- Magnetic Position ICs
- Pressure Sensors
- Thermistors

### Gas Chromatography

- Airflow Sensors
- Pressure Sensors



## BLOOD ANALYZERS

Blood analyzers using flow cytometry are used to examine microscopic cells and chromosomes by suspending them in a stream of fluid and passing them by an electronic detection apparatus in order to analyze their characteristics. Flow cytometry is often used to diagnose health disorders, such as blood cancers, as well as in research and clinical practice.

## Infrared Sensors

### HOA Series, HOA088X Series, HOA187X Series

Honeywell's infrared sensors may be used with an encoder wheel on the pump shaft to count shaft rotation. They are mounted facing each other. Detection occurs when an opaque object passes through the package slot, interrupting the infrared path.

### Benefits to Customer

- **Enables maximum position resolution:** Lead wires provide an alternate connection when PC board mounting is not possible, often ideal for use in potential

applications in which maximum position resolution is desired.

- **Operates in contaminated environments:** Infrared transmissive polysulfone housing features smooth optical faces without external aperture openings, often desirable when aperture blockage from airborne contaminants is a possibility.
- **Reliable:** Reliability is enhanced by the following: all solid-state design, low power consumption, no moving parts, and built-in strain relief for maximum

wire attachment strength. PC board mount is available.

- **Robust:** Variety of package styles, optical aperture sizes, and mounting options; analog and digital outputs (digital output options are 10K pull-up, open collector or totem-pole with inverting or non-inverting options).



HOA088X Series



HOA187X Series

## Magnetic Position Sensor ICs

### 2SS52M Series, SS552MT Series

Blood analyzers may employ the use of a series of rotating blood probes from which an extraction needle, or pipette, removes samples. Designers of the equipment must find a reliable solution for sensing position in a non-contact, mechanical system. To control the automated mechanisms, a series of Magnetic Position Sensor ICs may be used to detect the movement of the extraction needle, as shown in Figure 1.

#### Customer Benefits

- **Small:** The sensor is very small in size which simplifies mounting on the printed circuit board.
- **Low Gauss operation:** Can extend sensing distance to 1 in or more, depending on magnet strength.
- **Versatile:** Sensor can be activated with either a north or south magnetic field; standard digital sinking output makes it easy to interface with most electronic

circuits; accepts a wide supply voltage range of 3.8 V to 30 V, so it can use most available supply sources.



## Pressure Sensors

### Board Mount Pressure Sensors: TruStability® (HSC Series, SSC Series), 26PC Series

Honeywell's TruStability® and 26PC Series board mount pressure sensors are used to regulate the pressure in the pump system to draw and transport the blood samples.

#### Benefits to Customer

- **Accurate:** TruStability® sensors' exceptional accuracy is a result of leading-edge technology, precise manufacturing processes, and temperature compensation and calibration. TruStability® sensors have two levels of accuracy: the standard accuracy SSC Series offers  $\pm 2\%$  total error band, and the HSC Series offers  $\pm 1\%$  total error band, better than most competitive products.

- **Contaminant and corrosion resistant:** Ability to work with potential contaminants due to the wet/wet compatibility and a flow path with minimal dead space (26PC Series).
- **Product availability:** The sensor is available throughout the customers' product life cycle, so there is little concern for resubmission and approval to replace the sensors.
- **Reliable:** Minimizes downtime and improves throughput with enhanced quality and reliability (<100 ppm) (26PC Series).
- **Stable:** Enhanced accuracy in pressure monitoring to control the pumps and repeatable pressure, essential for the

spectrum analysis. Stability is a measure of how little the output signal of the pressure sensor will change from measurement to measurement. The long-term stability of Honeywell's TruStability® sensors is the best in the industry.



TruStability® HSC Series, SSC Series

## Thermistors

### 192 Series, 194 Series

Discrete thermistor temperature sensors are used to monitor the temperature of the chamber, the diffusion lamps, and oil-cooled motor to prevent them from overheating. There is also a need to measure the temperature as close to the sample as possible to control the sample temperature. Honeywell offers several types of configurations. The packaged sensors are available as discrete components for customer-built

assemblies, or Honeywell can provide a full assembly solution that the customer may simply pigtail into the system.

#### Benefits to Customer

- **Application flexibility:** Bare leads (192 Series) or insulated leads (194 Series) are designed to provide application flexibility.
- **Cost-effective:** Resistance temperature curve interchangeability designed to offer standardization of circuit components

and simplification of design and/or replacement enhances cost-effectiveness.

- **Small:** Small size often eases use in confined spaces.

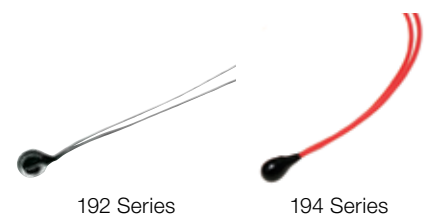

192 Series

194 Series





## GAS CHROMATOGRAPHY

Gas chromatography is a laboratory technique used in analytical chemistry to separate and analyze compounds that can be vaporized without decomposition.

### Airflow Sensors

#### AWM40000 Series

Medical gas chromatography requires precise and accurate monitoring and regulation of the flow of gases. Honeywell's airflow sensor's ceramic flow tube is designed to minimize outgassing with enhanced accuracy and reliability.

#### Benefits to Customer

- **Accurate:** Provides accurate control of delivery of carrier gases at required flow rate with enhanced sensitivity (the ability to detect ultra-low flow levels at 0.1 cubic centimeters).
- **Eases implementation:** Provides optional manifold mounting to reduce customers' effort of designing and implementing the sensors.
- **Minimizes risk of contamination:** Ceramic flow tube assembly with no outgassing minimizes risk of contamination.
- **Reliable:** Reduces downtime in many demanding operations with enhanced quality and reliability (<100 ppm).
- **Stable:** Provides accurate control of flow rate over time for consistent, stable, repeatable test results with enhanced stability.



AWM40000 Series

### Pressure Sensors

#### Board Mount Pressure Sensors: TruStability® (HSC Series, SSC Series)

Honeywell's TruStability® board mount pressure sensor is used to sense and control pressure of the gas stream to maintain a constant and precise flow.

#### Benefits to Customer

- **Accurate:** TruStability® sensors' exceptional accuracy is a result of leading-edge technology, precise manufacturing processes and temperature compensation and calibration. TruStability® sensors have two levels of accuracy: the standard accuracy SSC Series offers  $\pm 2\%$  total error band, and the HSC Series offers  $\pm 1\%$  total error band, better than most competitive products.
- **Stable:** Enhanced accuracy in pressure monitoring to control the pumps and repeatable pressure, essential for the spectrum analysis. Stability is a measure of how little the output signal of the pressure sensor will change from measurement to measurement. The long-term stability of Honeywell's TruStability® sensors is the best in the industry.



TruStability® HSC Series, SSC Series

## Flow Cytometry Block Diagram

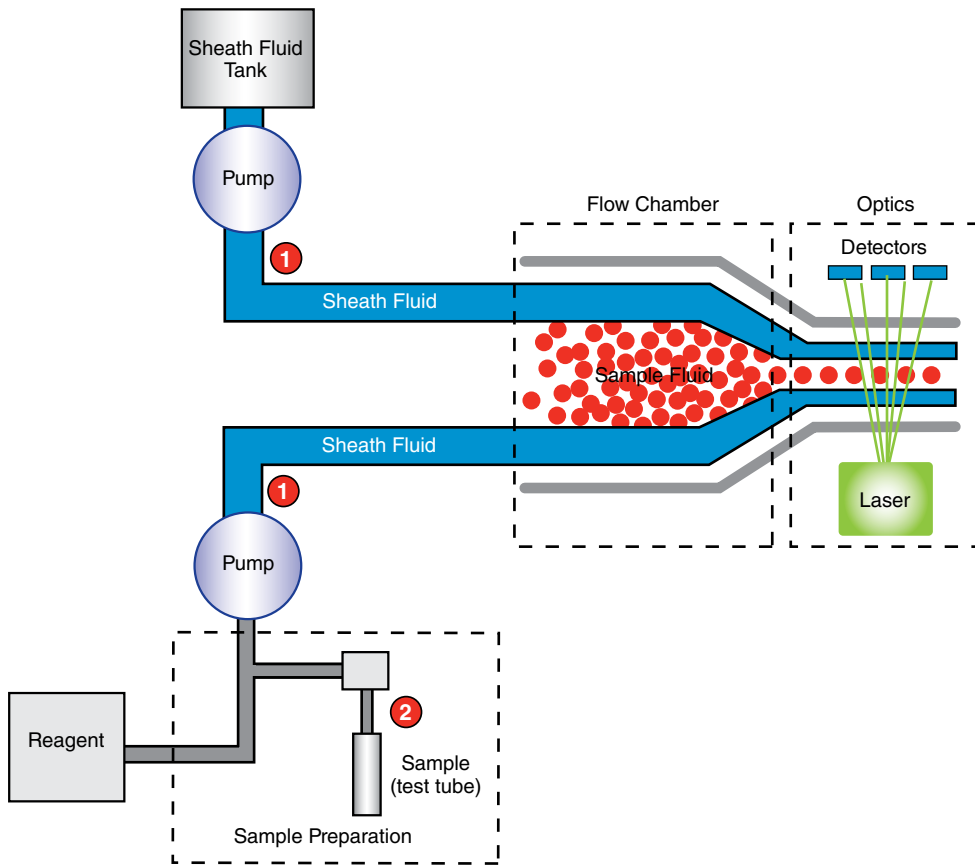

- 1 **Board Mount Pressure Sensors**  
TruStability®  
HSC Series, SSC Series  
or  
20PC Series
- 2 **Infrared Reflective Sensors**  
HOA1405 or HOA1180 Series  
or  
**Magnetic Position Sensor ICs**  
2SS52M or SS552MT Series

## Blood Analyzer Block Diagram

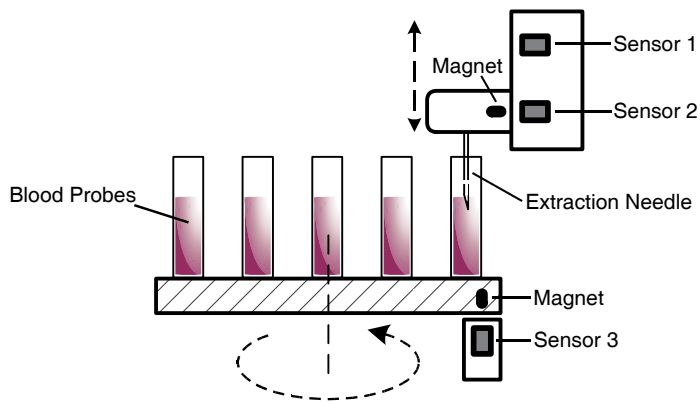

Sensors 1 and 2 detect the upper and lower positions of the extraction needle

Sensor 3 controls the end position of the blood probe holder





# Patient Monitoring Systems

Patient monitors are used in clinical environments (e.g., operating rooms, emergency rooms, intensive care, critical units and, increasingly, patient homes) to monitor and display the patient's vital signs, including ECG, SpO<sub>2</sub> (saturation of peripheral oxygen), blood pressure, respiration, and temperature. Patient monitors can be standalone or multi-parameter monitors. Honeywell sensors have been used in applications with blood pressure monitoring, glucose monitoring, respiratory monitoring, and temperature monitoring.

Blood pressure monitoring may be measured through either an inserted pressure transducer or non-invasively through a blood pressure cuff (NIBP).

Glucose monitoring measures the glucose level in the interstitial fluid. Continuous glucose monitoring allows examination of how the blood glucose level reacts to insulin, exercise, food, and other factors. Potential sensor applications for Honeywell sensors include the continuous glucose monitors used in critical care units, operating rooms, or patient recovery, where pumps are used to draw blood and/or return the blood to the body. Sensors could also be used in selected handheld glucose monitors if pressure needs to be regulated when drawing blood.

Respiratory monitoring displays critical respiratory indices including capnography, which monitors the concentration or partial pressure of CO<sub>2</sub> in the respiratory gases,

and spirometers, which measure direct in- and out-flow. Temperature monitoring consists of the monitoring of patient temperature.

## Sensor Solutions for Patient Monitoring

### Respiratory Monitoring

- Airflow Sensors

### Blood Glucose Monitoring

- Pressure Sensors

### Blood Pressure Monitoring

- Pressure Sensors

### Temperature Monitoring

- Thermistors

## RESPIRATORY MONITORING: Airflow Sensors

### Honeywell Zephyr™ HAF Series

Honeywell Zephyr™ Airflow Sensors measure the flow of air, oxygen, and nitrous oxide. They may be used so that the desired mixture, as set by the doctor, is delivered to the patient.

#### Benefits to Customer

- **High 2.5% accuracy:** Allows for very precise airflow measurement, often ideal for demanding applications with high accuracy requirements.
- **Customizable:** Allows the sensor to be designed to meet specific end-user needs.
- **High sensitivity at very low flows:** Allows the customer's application to detect presence or absence of airflow.
- **High stability:** Reduces errors due to thermal effects and null shift to provide accurate readings over time, often eliminating

need for system calibration after printed circuit board (PCB) mount and periodically over time.

- **Low pressure drop:** Low pressure drop typically improves patient comfort in medical applications, and reduces noise and system wear in components such as motors/pumps.
- **Saves customers time and money:** Linear output provides a more intuitive sensor signal than the raw output of basic airflow sensors, often eliminating the need for customers having to linearize the output which can help to reduce production and design costs and implementation time.



HAF Series

## BLOOD GLUCOSE MONITORING: Pressure Sensors

### Board Mount Pressure Sensors: TruStability® (HSC Series, SSC Series)

Honeywell's TruStability® board mount pressure sensors are used to control the pumps used to draw the blood and return it to the patient in continuous glucose monitors used in critical care units. These pressure sensors meet the size requirements for selected handheld glucose meters with the need of pressure measurement of the glucose monitoring.

#### Benefits to Customer

- **Improves patient safety with best-in-class low drift:** Low drift in the pressure sensor allows accurate control of the pump pressure.
- **Accurate:** Accurate pressure monitoring in blood pressure monitors allows measurement of blood pressure with enhanced stability and minimal drift over time. Honeywell's TruStability® sensors' exceptional accuracy is a result of leading-edge technology, precise manufacturing processes, and temperature compensation and calibration. TruStability® sensors have two levels of accuracy: the standard accuracy SSC Series offers

$\pm 2\%$  total error band, and the HSC Series offers  $\pm 1\%$  total error band, better than most competitive products.

- **Portability:** Small size improves handheld glucose monitor portability.
- **Stable:** Stability is a measure of how little the output signal of the pressure sensor will change from measurement to measurement. The long-term stability of Honeywell's TruStability® sensors is the best in the industry.



TruStability® HSC Series,  
SSC Series

## BLOOD PRESSURE MONITORING: Pressure Sensors

### Board Mount Pressure Sensors: TruStability® (HSC Series, SSC Series), 20PC Series, CPC Series

Honeywell's board mount pressure sensors may be used in blood pressure monitors to measure blood pressure.

Honeywell's TruStability®, 20PC, and CPC Series board mount pressure sensors may be used in blood pressure monitors. The CPC Series may also be used with a customer-provided amplifier or ASIC-based solution for a signal conditioned output.

#### Benefits to Customer

- **Accurate:** Accurate pressure monitoring in blood pressure monitors allows measurement of blood pressure with enhanced stability and minimal drift over time. Honeywell's TruStability® sensors' exceptional accuracy is a result of leading-edge technology, precise manufacturing processes, and temperature compensation and calibration. TruStability® sensors have two levels of accuracy: the standard accuracy SSC Series offers

$\pm 2\%$  total error band, and the HSC Series offers  $\pm 1\%$  total error band, better than most competitive products.

- **Portability:** Small sensor size improves blood pressure monitor portability.
- **Stable:** Stability is a measure of how little the output signal of the pressure sensor will change from measurement to measurement. The long-term stability of Honeywell's TruStability® sensors is the best in the industry.



TruStability® HSC Series,  
SSC Series



20PC Series



CPC Series

## TEMPERATURE MONITORING: Thermistors

### 192 Series, 194 Series

Honeywell's 192 Series and 194 Series discrete thermistor temperature sensors are used to monitor patient temperature. Honeywell offers several types of configurations. The packaged sensors are available as discrete components for customer-built assemblies, or Honeywell can provide a full assembly solution that the customer may simply pigtail into the system.

#### Benefits to Customer

- **Application flexibility:** Bare leads (192 Series) or insulated leads (194 Series) are designed to provide application flexibility.

- **Cost-effective:** Resistance temperature curve interchangeability designed to offer standardization of circuit components and simplification of design/replacement enhances cost-effectiveness.
- **Small:** Small size often eases use in confined spaces.



192 Series



194 Series



# Hospital Hardware

Honeywell's sensors and switches have been used in a variety of hospital hardware to help minimize downtime, provide stable and repeatable performance, and meet demanding requirements in harsh environments.

## Solutions for Hospital Hardware

### Medication Dispensing Cabinets

- Magnetic Position Sensor ICs

### Infant and Laboratory Incubators

- Flexible Heater Assemblies
- Humidity Sensors
- Thermistors

### Hospital Beds

- MICRO SWITCH™ Position Switches
- Pressure Sensors

### Sterilizers, Autoclaves, and Blood

### Refrigerators

- Thermistors

## MEDICATION DISPENSING CABINETS: Magnetic Position Sensor ICs

### SS440/SS440R Series

Magnetic position sensor ICs are designed for a variety of potential applications, including use with remote locking and unlocking of medication dispensing cabinets. Their small size often allows for design into many compact, automated, lower-cost assemblies. A thermally-balanced integrated circuit allows accuracy over a full temperature range.

#### Benefits to Customer

- **Energy-efficient:** Low power consumption enhances energy efficiency.
- **Enhances security:** Provides a level of security; minimizes medication dispensing errors by utilizing electronic sensing solutions to enable remote locking and unlocking of medication drawers.
- **Fast response:** Provides fast response time.

- **Reliable:** Improves durability and reduced repair and maintenance cost with a non-contact solution.
- **Small:** Small sensor size eases fit in drawers and enables smooth and efficient operation.

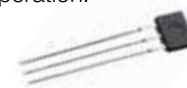

SS400 Series

## INFANT AND LABORATORY INCUBATORS: Flexible Heater Assemblies

### A3100 Series, A3200 Series, A3400 Series, C3100 Series, C3200 Series, C3400 Series

Flexible heater assemblies can be applied to the incubator door to help heat the incubator's internal temperature and to also maintain clear visibility through the door wall.

#### Benefits to Customer

- **Total thermal management solution:** Value-added heater assemblies include mounting, temperature monitoring, and control capabilities. Honeywell can design and manufacture complete heater turnkey assemblies, including

supplying a vulcanized or adhered heater assembly to a heat plat, heat sink, mounting bracket, or cover.

- **Uniform heating:** Count on even heat distribution across the heater surface.
- **Eases system qualification:** Honeywell offers UL- and CSA-recognized components.
- **Flexible:** Numerous configurations (flat, transparent composite, high temperature), manufacturing materials (silicon, kapton, polyester Indium Tin Oxide, and other flexible dielectric

components) and watt densities (single or multiple) provide application options.

- **High-limit temperature controls:** Built-in temperature detection device can help minimize system overheating.
- **Stable:** Uniform temperature minimizes heat loss.



3100 Series



## INFANT AND LABORATORY INCUBATORS: Humidity Sensors

Honeywell HumidCon™ HIH6130/6131 Series, HIH-4000 Series, HIH-4020/4021 Series, HIH-4030/4031 Series, HIH-5030/5031 Series, HCH-1000 Series

Honeywell's humidity sensors monitor the medical incubator system to maintain a desired optimum level of humidification in the chamber with accurate dew-point and absolute humidity and moisture measurement.

### Benefits to Customer

- **Industry-leading long term stability (1.2 RH% over 5 years):** Minimizes system performance issues, helps support system uptime, and eliminates the need to recalibrate the sensor in the application (Honeywell HumidCon™).
- **Industry-leading Total Error Band (TEB) ( $\pm 5\%$  RH):** Provides the sensor's true accuracy reducing manufacturing time, supports system warranty requirements, helps optimize system uptime, and provides excellent sensor interchangeability (Honeywell HumidCon™).

- **Lowest total cost solution:** Offers customers the lowest total cost solution due to the sensor's industry-leading Total Error Band and being a combined humidity/temperature sensor (Honeywell HumidCon™).
- **Cost-effective:** Surface mount device (SMD) packaging on tape and reel allows for use in automated, high-volume, lower-cost pick-and-place manufacturing.
- **Durable:** Multi-layer construction and a hydrophobic filter provides enhanced resistance to condensation and contaminants.
- **Flexible:** Small, space-saving housing profile allows for application flexibility. The low current draw allows for use in low-current-draw, battery-operated systems.
- **Reliable:** Supports demanding system performance requirements with enhanced accuracy and response time.



HIH6130/6131 Series



HIH-4000 Series



HIH-4020/4021 Series



HIH-4030/4031 Series



HIH-5030/5031 Series



HCH-1000 Series

## INFANT AND LABORATORY INCUBATORS: Thermistors

192 Series, 194 Series

Honeywell's discrete thermistor temperature sensors are designed to monitor temperature. The sensors are coupled to a microcontroller designed to measure air stream temperature and interact with the controller that regulates the temperature of the air stream. The packaged sensors are available as discrete components for customer-built assemblies, or Honeywell can provide a full assembly solution that the customer may simply pigtail into the system.

### Benefits to Customer

- **Application flexibility:** Bare leads (192 Series) or insulated

leads (194 Series) are designed to provide application flexibility.

- **Cost-effective:** Resistance temperature curve interchangeability designed to offer standardization of circuit components and simplification of design/replacement enhances cost-effectiveness.
- **Small:** Small size often eases use in confined spaces.



192 Series



194 Series

## HOSPITAL BEDS: MICRO SWITCH™ Position Switches

SM Series, SX Series, Z Series, Basic Switches

Honeywell's precise position switches are used to determine minimum and maximum position of electrically adjustable hospital beds.

### Benefits to Customer

- **MICRO SWITCH™ technology:** Accurate, repeatable, and durable with extended life.
- **Customizable:** Offers a variety of straight, roller, simulated roller, and special actuators from which to choose.

- **Reliable:** Provides repeatable and consistent performance within a range of conditions.
- **Industry-leading current capability:** A wide range of current ratings, from 0.1A to 10 A.



SM Series



SX Series



Z Series

## HOSPITAL BEDS: Pressure Sensors

### Board Mount Pressure Sensors: TruStability® (HSC Series, SSC Series), 20PC Series, CPC Series

Honeywell's board mount pressure sensors are used to measure air pressure and monitor the inflation and deflation of the mattress air columns to minimize the chance that bedridden patients will develop bedsores.

#### Benefits to Customer

- **Accurate:** Accurate pressure monitoring in hospital beds allows enhanced stability and minimal drift over time. Honeywell's TruStability® sensors' exceptional accuracy is a result of leading-edge technology, precise manufacturing processes, and temperature compensation and calibration. TruStability® sensors have two levels of accuracy: the standard accuracy SSC Series offers  $\pm 2\%$  total error band, and the HSC Series offers  $\pm 1\%$  total error band, better than most competitive products.

- **Reliable:** In demanding operations minimizes downtime and improves throughput with enhanced quality and reliability (<100 ppm).
- **Stable:** The long-term stability of Honeywell's TruStability® sensors is the best in the industry.



TruStability® HSC Series,  
SSC Series



20PC Series



CPC Series

## STERILIZERS, AUTOCLAVES, AND BLOOD REFRIGERATORS: Thermistors

### 192 Series, 194 Series

Honeywell's discrete thermistor temperature sensors are designed to monitor temperature. The sensors are coupled to a microcontroller designed to measure air stream temperature and interact with the controller that regulates the temperature of the air stream. The packaged sensors are available as discrete components for customer-built assemblies, or Honeywell can provide a full assembly solution that the customer may simply pigtail into the system.

#### Benefits to Customer

- **Application flexibility:** Bare leads (192 Series) or insulated leads (194 Series) are designed to provide application flexibility.

- **Cost-effective:** Resistance temperature curve interchangeability designed to offer standardization of circuit components and simplification of design/replacement enhances cost-effectiveness.
- **Small:** Small size often eases use in confined spaces.



192 Series



194 Series





# Surgical Instruments

Honeywell sensors have been used to help control the operation of various surgical instruments including orthopedic bone drills to detect the force of the drill bits and improve patient safety, regulating air and

gas pressure in endoscopes, controlling the pressure level for patient wound suction therapy, and sensing pressure in a fluid management system.

## Sensor Solutions for Surgical Fluid Management Systems

- Force Sensors**
- Pressure Sensors**

### Force Sensors in Surgical Fluid Management

1865 Series, FSS Series, FSS-SMT Series

Honeywell's force sensors can help regulate the pressure at the pump head of a fluid management system, and as a back-up safety device to the direct pressure measurement at the joint.

#### Benefits to Customer

- **Portable:** Sensor's small size improves portability.
- **Energy efficient:** Sensor's small size allows low power consumption.
- **Reliable:** Enhanced quality (<100 ppm) provides enhanced reliability in many demanding operations.

- **Rugged design:** 1865 Series offers a rugged design that resists scratching and denting.
- **Stable:** Ability to detect pressure accurately over time with enhanced stability and low drift.



### Pressure Sensors in Surgical Fluid Management Systems and Insufflators

Board Mount Pressure Sensors: TruStability® (HSC Series, SSC Series), ASDX Series

Honeywell's TruStability® and ASDX Series board mount pressure sensors are used to sense pressure directly at the joint site during arthroscopic surgery, and monitor pressure for insufflators during endoscopic procedures.

#### Benefits to Customer

- **Accuracy:** Enhanced accuracy and ability to detect low pressure improves the accuracy of the pressure measurement. TruStability® sensors' exceptional accuracy is a result of leading-edge technology, precise manufacturing processes, and temperature compensation and calibration. TruStability® sensors have two levels of accuracy: the standard accuracy SSC Series offers  $\pm 2\%$  total error band, and the HSC Series offers  $\pm 1\%$  total error band, better than most competitive products.
- **Improves patient safety:** Allows quick reaction with a fast response time.

- **Easy to design in:** Customization of pressure ranges, connections, calibration, and temperature compensation minimizes customer's design-in effort.
- **Stable:** Stability is a measure of how little the output signal of the pressure sensor will change from measurement to measurement. The long-term stability of Honeywell's TruStability® sensors is the best in the industry.





# Dental Equipment

Honeywell's sensors may potentially be used in many dental equipment applications including dental imaging systems, dental chairs, and pressure-operated dental instruments including drills, water sprays, and air blasters.

## Sensor Solutions for Dental Equipment

### Dental Chairs

- Magnetic Position Sensor ICs
- MICRO SWITCH™ Watertight Miniature Switches

### Dental Imaging Systems

- Infrared Sensors
- Magnetic Position Sensor ICs

### Pressure-Operated Dental Instruments

- Board Mount Pressure Sensors

## DENTAL IMAGING SYSTEMS: Magnetic Position Sensor ICs

### SL353 Series, S549AT Series

Magnetic position sensor ICs are used to provide accurate motion control and positioning of the dental imaging system.

#### Benefits to Customer

- **Energy efficient:** Hall-effect sensors consume little energy and help improve motor efficiency. The SL353 Series' supply voltage (as low as 2.2 Vdc) combined with very low average current reduces power consumption and provides extended battery life.
- **Push-pull output does not require external pull-up resistor:** Simplifies interface with common electrical circuits and potentially reduces PC board space and costs to the customer (SL353 Series).

- **Non-chopper stabilized design:** Does not utilize chopper stabilization, eliminating noise generated by products using this technique (SL353 Series).
- **Accurate motion control:** Detects home position and different segments of the sensor head rotation.
- **Fast response:** Provides a fast response time.
- **Reliable:** Improved durability and reduced repair and maintenance cost with a non-contact solution.



SL353 Series



S549AT Series

## DENTAL CHAIRS: MICRO SWITCH™ Watertight Switches

### ZW Series, ZD Series, V15W Series

This miniature-sized basic switch can be used in automatic dental chair foot pedals to control chair position, limiting the dental staff from touching items and risking cross contamination.

#### Benefits to Customer:

- **MICRO SWITCH™ technology:** Accurate, repeatable, and durable with extended life.
- **Customizable:** Offers a variety of straight, roller, simulated roller, and special actuators from which to choose.
- **Reliable:** Provides repeatable and consistent performance within a range of conditions.

- **Industry-leading current capability:** A wide range of current ratings from 0.1A to 10A.



V15W Series



## DENTAL IMAGING SYSTEMS: Infrared Sensors

HOA0881 Series, HOA1180 Series, HOA1870 Series

Honeywell's infrared sensors have been used in dental imaging systems to obtain dental images.

### Benefits to Customer

- **Enables maximum position resolution:** Offers lead wires which provide alternate electrical connection when PC board mounting is not possible, often ideal for use in potential applications in which maximum position resolution is desired (HOA1870 Series).
- **Operates in contaminated environments:** Utilizes an infrared transmissive polysulfone housing which features smooth optical

faces without external aperture openings, desirable when aperture blockage from airborne contaminants is a possibility (HOA0881 Series).

- **Reliable:** Utilizes a built-in strain relief for maximum wire attachment strength (HOA0881 Series).



HOA0881 Series



HOA1180 Series



HOA1870 Series

## PRESSURE-OPERATED DENTAL INSTRUMENTS: Pressure Sensors

Board Mount Pressure Sensors: 26PC Series

Honeywell's 26PC Series board mount pressure sensor is used to keep the water flow constant and at an adjusted level to provide a smooth operation of the dental instrument (e.g., drills, water sprays, air blasters).

### Benefits to Customer

- **Reliable:** Minimizes downtime in demanding operations, and improves throughput with enhanced quality and reliability (<100 ppm).

- **Stable:** Pressure monitoring to control water flow level with enhanced accuracy.
- **Water-resistant and contaminant-resistant:** Ability to work with water flow and contaminants with the wet/wet compatibility and a flow path with minimal dead space.



26PC Series





## **Warranty/Remedy**

Honeywell warrants goods of its manufacture as being free of defective materials and faulty workmanship. Honeywell's standard product warranty applies unless agreed to otherwise by Honeywell in writing; please refer to your order acknowledgement or consult your local sales office for specific warranty details. If warranted goods are returned to Honeywell during the period of coverage, Honeywell will repair or replace, at its option, without charge those items it finds defective. The foregoing is buyer's sole remedy and is in lieu of all other warranties, expressed or implied, including those of merchantability and fitness for a particular purpose. In no event shall Honeywell be liable for consequential, special, or indirect damages. While we provide application assistance personally, through our literature and the Honeywell web site, it is up to the customer to determine the suitability of the product in the application. Specifications may change without notice. The information we supply is believed to be accurate and reliable as of this printing. However, we assume no responsibility for its use.

## **Customers know Honeywell by two simple words: "Problem solved."**

Our corporate tradition of delivering quality and innovation is infused throughout Honeywell Sensing and Control, a global leader in cost-effective, problem-solving sensor and switch solutions.

For more information about Sensing and Control products, visit [www.honeywell.com/sensing](http://www.honeywell.com/sensing) or call +1-815-235-6847  
Email inquiries to [info.sc@honeywell.com](mailto:info.sc@honeywell.com)

Sensing and Control  
Automation and Control Solutions  
Honeywell  
1985 Douglas Drive North  
Golden Valley, MN 55422  
USA  
+1-815-235-6847  
[www.honeywell.com](http://www.honeywell.com)

000694-3-EN IL50 GLO  
January 2012  
© 2012 Honeywell International Inc.  
All rights reserved.



# **Honeywell**